



Touchwin Special function component

User's manual

Catalog

1	Event Button	6
1.1	Introduction	6
1.2	Procedure	7
1.2.1	Display history event, Trend	7
1.2.2	Time trend control	10
1.2.3	XY poly trend	10
1.3	Notes	11
2	Protection function via password	12
2.1	Introduction	12
2.1.1	Direct mode	12
2.1.2	Indirect mode	13
2.2	Procedure	13
2.2.1	Direct mode	13
2.2.2	Indirect mode	15
2.3	Note	19
3	print function	20
3.1	Introduction	20
3.2	Procedure	21
3.2.1	Requirements	21
3.2.2	Preparation	22
3.2.3	Connection	22
3.2.4	Project editing	23
3.3	Notes	31
4	Dual port communication	32
4.1	Introduction	32
4.2	Procedure	32
4.2.1	Requirements	33
4.2.2	Preparation	33
4.2.3	Project editing	33
4.3	Note	40
5	Alarm list	41
5.1	Introduction	41
5.2	Precedure	41
5.3	Samples	43
5.3.1	'Alarm list' editing	44
5.3.2	'Event button' editing	45
5.3.3	'Digital input' editing	45
5.3.4	'Lamp button' editing	46
5.4	Notes	46
6	Net function	47
6.1	Introduction	47

6.2	Procedure	48
6.2.1	Project editing on panel(host net).....	49
6.2.2	Project editing on panel(salve net 1#)	51
6.2.3	Project editing on panel(salve net 2#).....	52
6.3	Note.....	55
7	Data grid & Grid control	56
7.1	Introduction.....	56
7.2	Description	56
7.3	Description on setting	60
8	XY curve.....	64
9	Sample save	70
10	XY Curve Ex.....	75
10.1	Introduction.....	75
10.2	Description	75
10.3	Description of parameter setting.	78
11	Import CSVdata	80
11.1	Introduction	80
11.2	Description	80
11.3	Description of parameter setting.	85
12	Export CSV data	89
12.1	Introduction.....	89
12.2	Description	89
12.3	Description of parameter setting	97
13	Time trend control.....	101
13.1	Introduction.....	101
13.2	Procedure	101
13.2.1	'time trend curve'with 'Rotate overwrite' mode.....	101
13.2.2	'Time trend'with 'stop'mode	110
13.3	Description of parameters	113
14	Move animal	117
14.1	Introduction.....	117
14.2	Procedure	117
14.2.1	Track editing	117
14.2.2	Example- Scroll text.....	121
14.3	Description of parameter setting	124
15	Rotate animal	126
15.1	Introduction.....	126
15.2	Procedure	126
15.2.1	Introduction of simple animation	126
15.2.2	Example- butterfly.....	132
15.3	Description of parameter setting	136
16	Recipe	138
16.1	Introduction.....	138
16.2	Example	138

16.2.1	Write recipe datas to PFW registers.	139
16.2.2	Download Recipe	141
16.2.3	Modify and display the recipe data	142
16.2.4	Display name of the recipe	144
16.2.5	Switch button for Index	145
16.2.6	UPload recipe	147
17	Export sample data.....	149
17.1	Procedure	149
17.2	Example	152

Preface

This chapter describes how to use the Special function component ,including component introduction ,procedure and samples .Welcome to give good suggestions .

Note :Regarding common component please refer to <HMI manual Basic>

Please use 2.c.3 version of software or above to open the samples .

1 Event Button

1.1 Introduction

“Event Button” is used to be matched with data dealing component to achieve operations (page changing, confirm, movement). Its advantage is obviously in the performance of “History data map”, “Real Trend Map”, “Display history Event”, “Time trend control” and “XY curve” and so on.

Features:

(1) “Page changing” matched with “history data map”

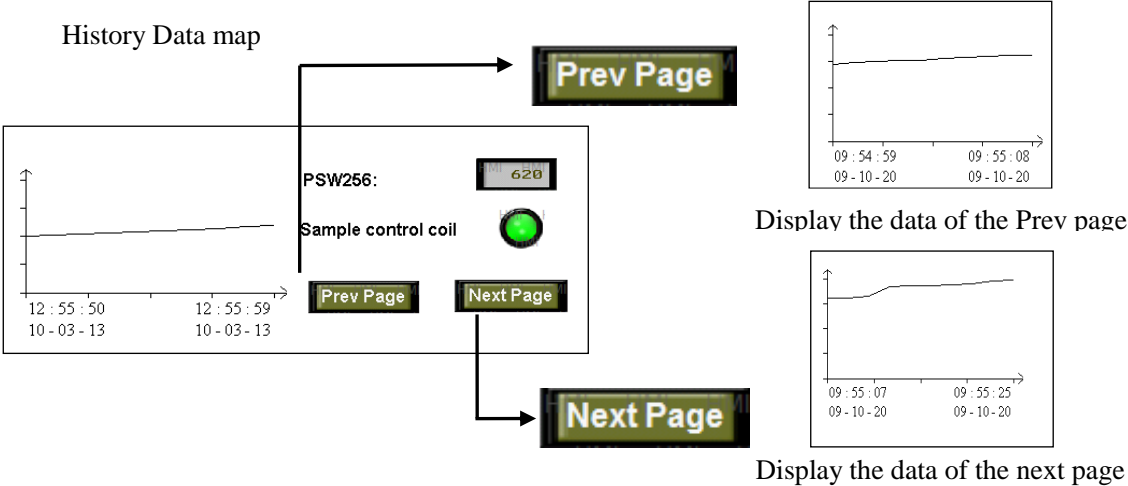

(2) “Movement” matched with “Time trend control”

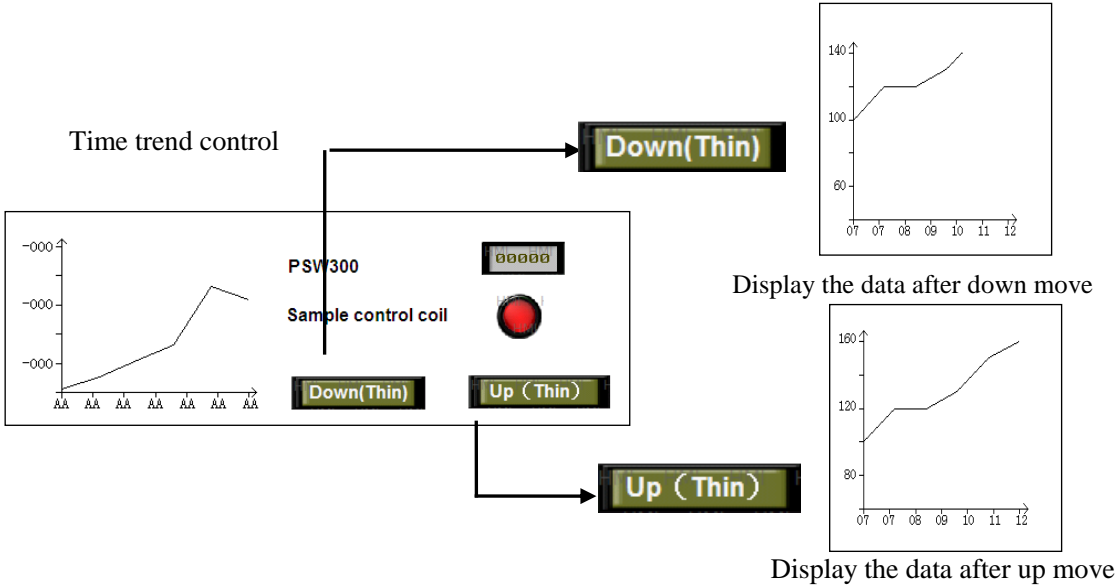

(3) “Clear”, “Clear and draw”, “Reserve and draw”, “Repete and Draw” matched with “XY curve”

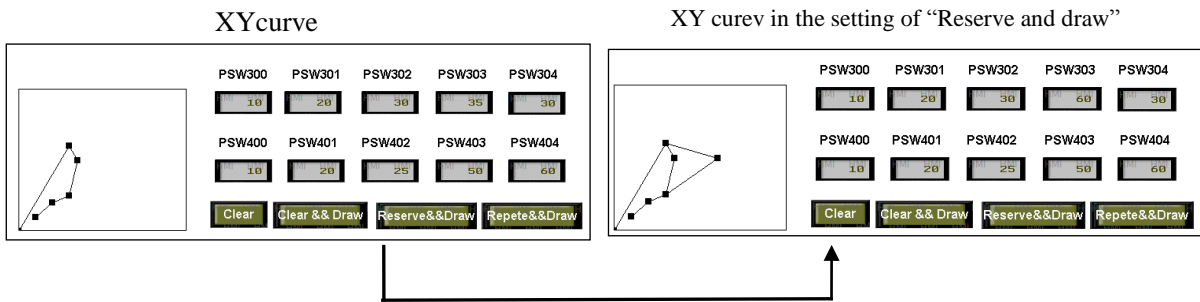

1.2 Procedure

Step 1: click the component  from toolbar and leave it to the target position, as below

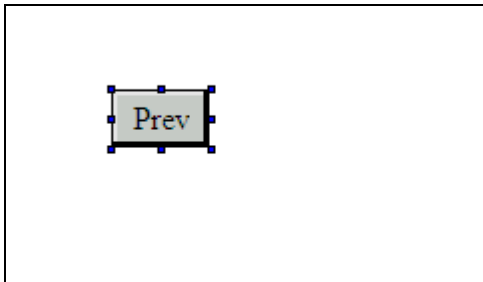

- Make it small or big via boundary points.

Step 2: property setting, including “Event, Button, Color, Position”

Property -----“Event”

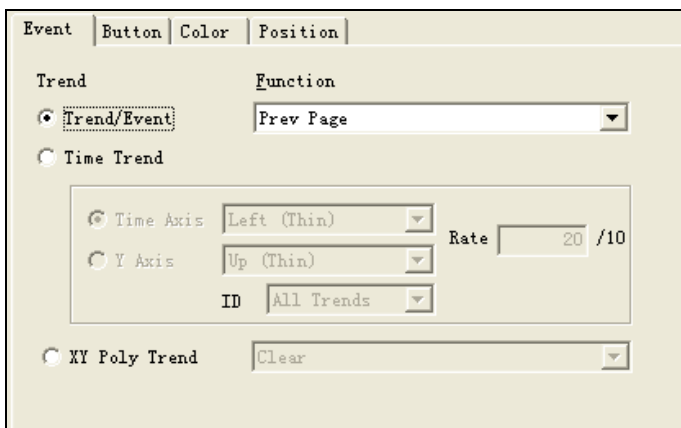

According to event object, there are 3 kinds:

- “Display history event, Trend ” : support “page changing, confirm, clear” operations
- Time trend: coordinate movement
- XY curve: Clear, Clear and draw, Reserve and draw, Repete and draw

The following chapter will describe the procedure:

1.2.1 Display history event, Trend

- Display history event——confirm, choose Item and page changing to the event

Trigger time	Event	Confirm time
10-03-15 08:53	Over temperature	10-03-15 08:53
10-03-15 08:53	Under temperature	10-03-15 08:53
10-03-15 08:53	Over Hydraulic pressure	10-03-15 08:53
10-03-15 08:53	Under Hydraulic pressure	10-03-15 08:53

PSB400
PSB401
PSB402
PSB403
PSB404



Prev Item

Prev page

Confirmn

Next Item

Next page

Record clear

Shown as above

Prev Item,Next Item: press the key to move the Data frame up and down

Prev page,Next page :page changing

Confirm: check the confirm time

Clear record : clear all the data in the table

How to: Select “history event ,trend” in the “Event ”property,then click the corresponding operation “Prev item”, “Next item”, “Prev page”, “Next page”, “confirm”, “clear record”in the sequence of above.

For example : the setting of “Prev Item” is shown as below:

Prev Item

→

Move the data frame up

Function

Prev Item ▾

Prev Page

Next Page

Prev Item

Next Item

OK

ResetContent

The setting of “Next page ”is shown as below

Next page

→

Turn to the next page

Function

Next Page ▾

Prev Page

Next Page

Prev Item

Next Item

OK

ResetContent

The setting of the “confirm”

Confirmn

→

Check out the “confirm time”

Function

OK ▾

Prev Page

Next Page

Prev Item

Next Item

OK

ResetContent

The setting of the “record clear”

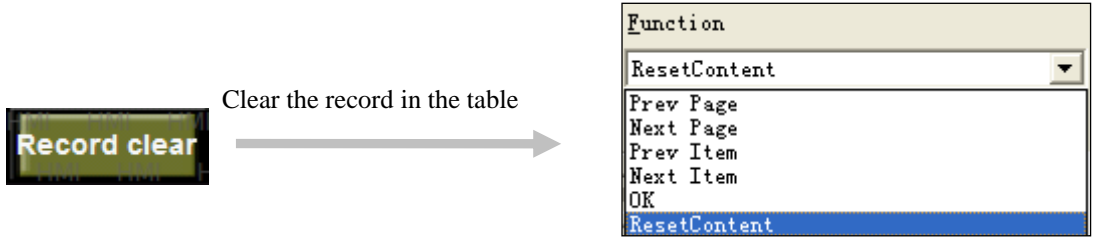

- History Data map—— Page changing (Prev page,Next page)

Display the data on difference page

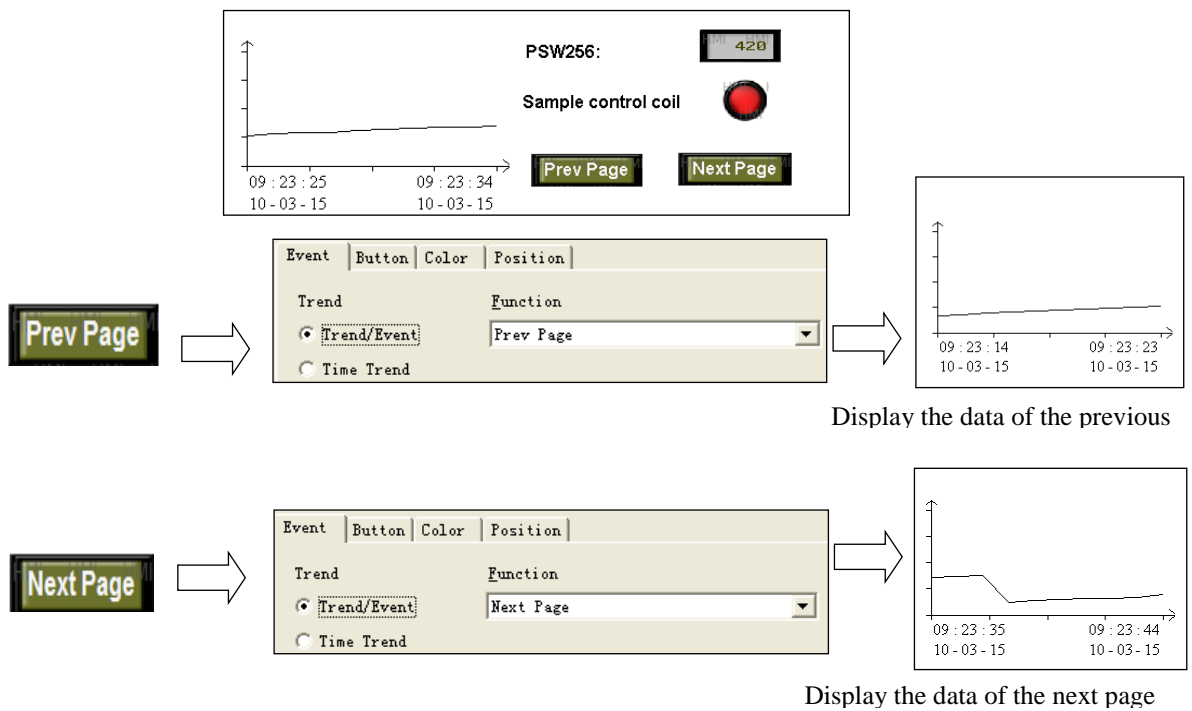

1.2.2 Time trend control

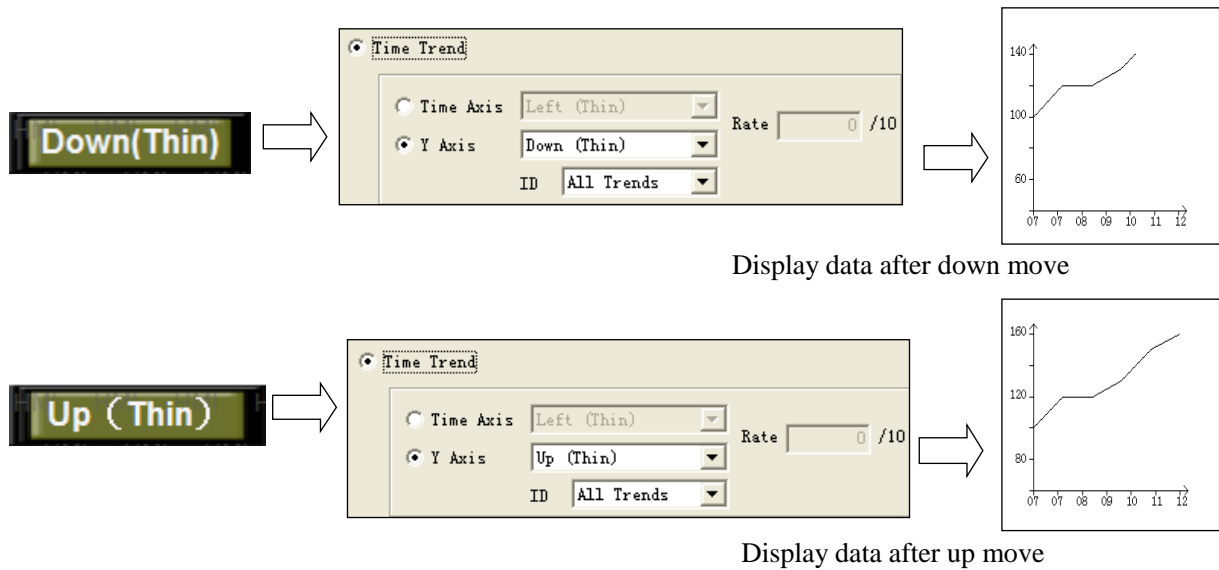

The function corresponding to time trend control is shown as below:

Move up(wide/thin):move the coordinate up(movement amount is based on the selection of wide or thin)

Move down(wide/thin):move the coordinate down(movement amount can be selected in wide or thin mode)

Zoom out(wide/thin): zoom the current coordinate out (the ratio is based on the selection of wide or thin)

Zoom in(wide/thin): zoom the current coordinate in (the ratio is based on the selection of wide or thin)

Show: show the current curve,corresponding with "hiding".

Hide: hide the current curve,corresponding with "display".

Reset: return to initialized value.

Zoom out/in in ratio:zoom the coordinate out or in according to the setting ratio.

1.2.3 XY poly trend

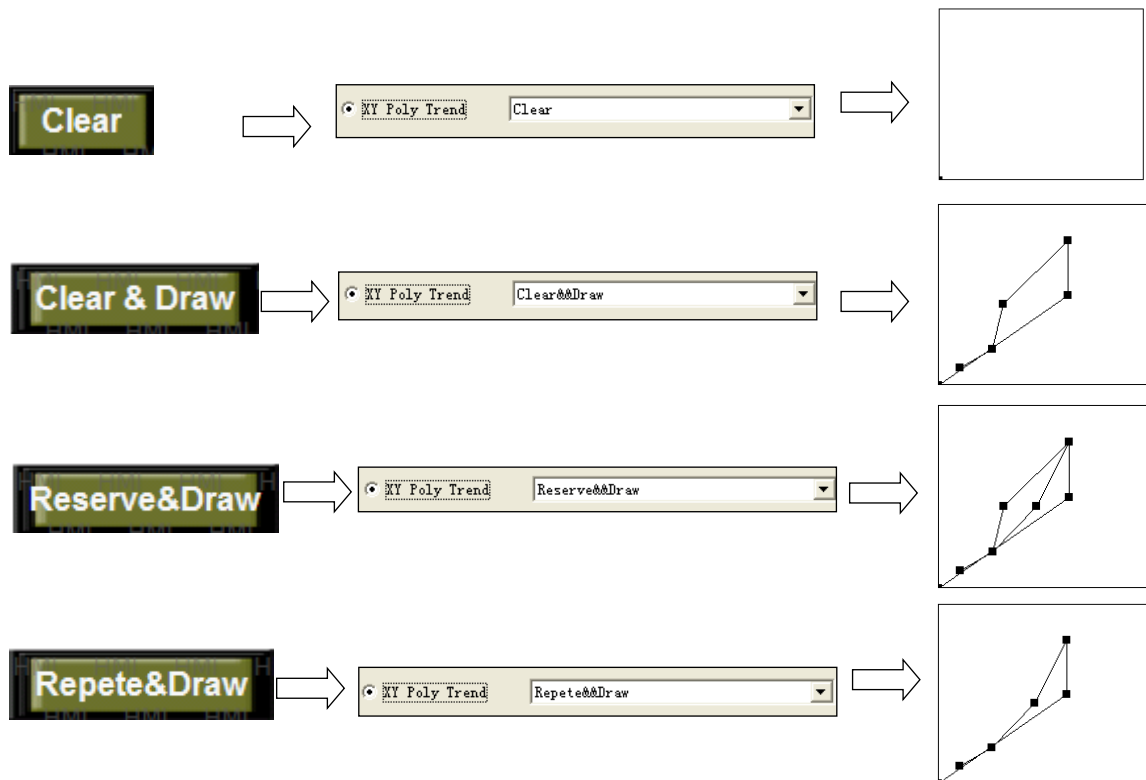

More details is showed as below:

Clear: all the curve is cleared.

Clear and draw: clear all the curve,then draw the new curve.

Rserve and draw: keep the old curve and draw the new curve.

Repeat and draw:draw the curve in circulation way,once the data changes ,the new curve replace the old curves.



More details regarding the property setting“button,color position”,please refer to the component “button”parts.



The details about “clear ,reserve and draw ,clear and draw, repeat and draw ”please refer to the component “XY curve” parts.

1.3 Notes

Only one objective component matched with “event button ” can be authorized in one screen,for example,if the event button is used for page changing of “display histroy data” , then this kind component like “history event”or “XY curve” is not allowed to use in this screen.

2 Protection function via password

2.1 Introduction

This function is used to limit the access authority.

There are 2 modes:

- (1) **Direct mode:**enter into the password screen after clicking the objective component. This mode is active only to “screen jump ”component.
- (2) **Indirect mode:**jump into the “60001” screen via “screen jump”component, the objective component is available when the password is correct.

Component mached with this function is shown as below:

Mode	Component
Direct mode	Screen jump
Indirect mode	
Button	Button with lamp
Digital input	Text input
Set data	Window button
Down recipe	Up recipe
Event button	

2.1.1 Direct mode

Click the component “screen jump”,enter the password in the dialog box,then jump into the objective screen when the password is correct.

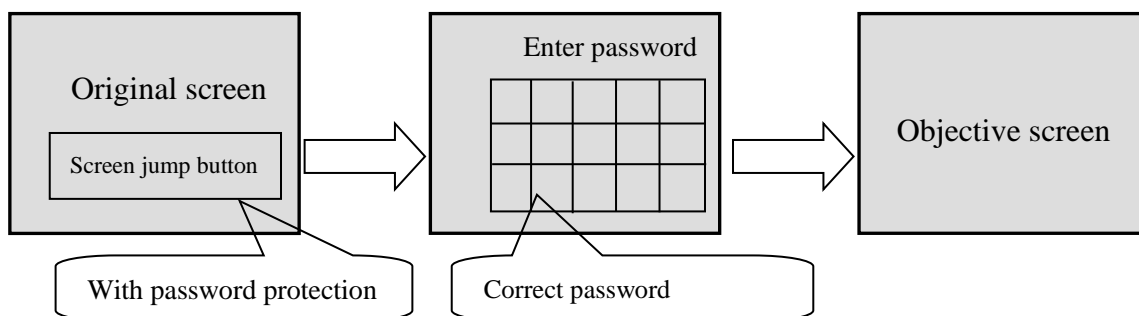

2.1.2 Indirect mode

When you use other component with password function ,please jump into “60001”screen to enter correct password first.

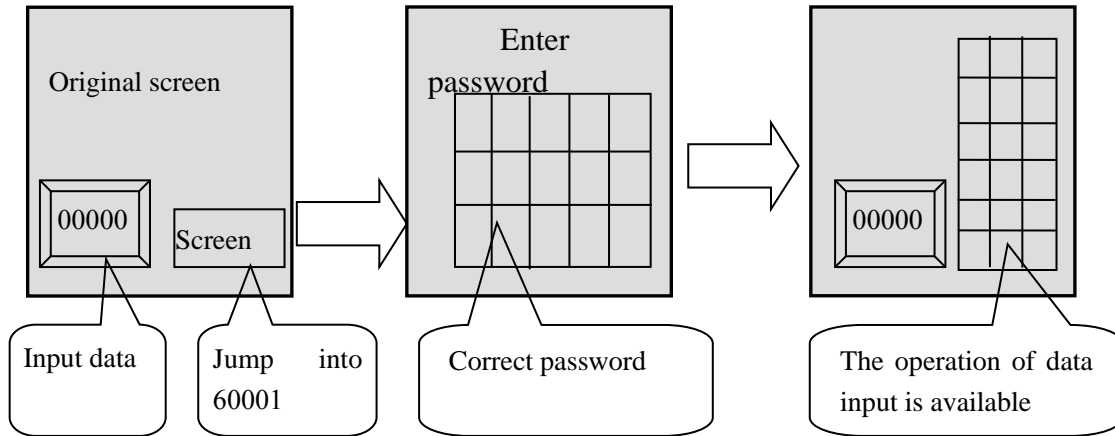

2.2 Procedure

2.2.1 Direct mode

This mode is available only to “screen jump ”component.

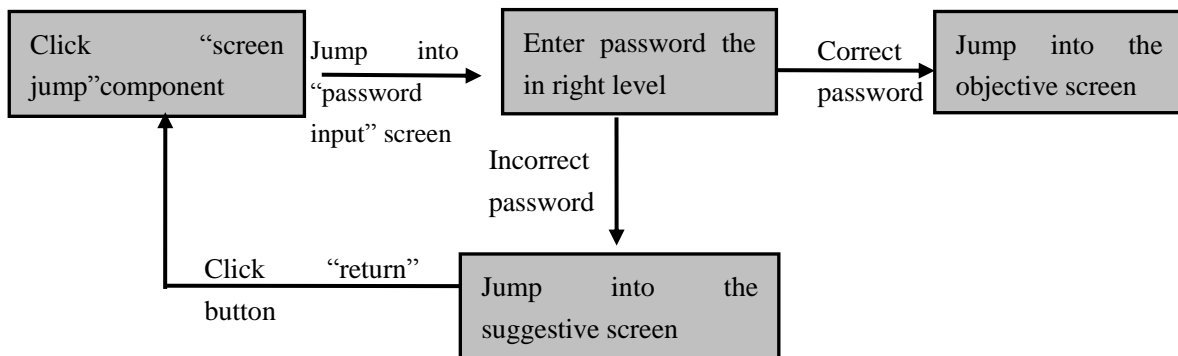

Purpose: jump into the second screen with correct password .

Procedure

The procedure is comprised of screen editing, system setting, and emulator offline.

Step1: screen editing

Screen1:Click component  from toolbar and leave it to the objective position,modify the property “operate”and “button”.

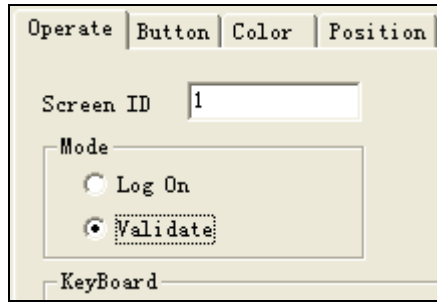

- Jump into the screen 2
- Select “validate”mode

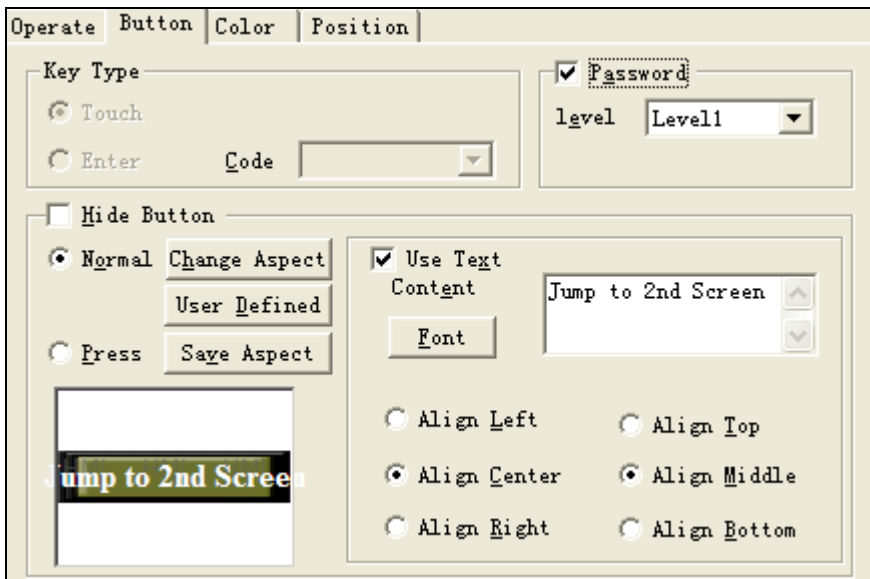

- Change the text content
- Click the password level with “Level1”

其它设定方式自行定义。

Add screen 2:right click the screen in the project bar, press the insert then edit to show the screen ID.

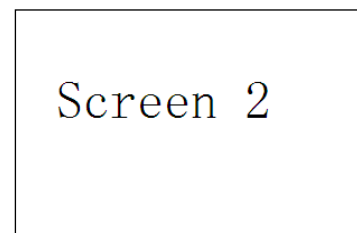
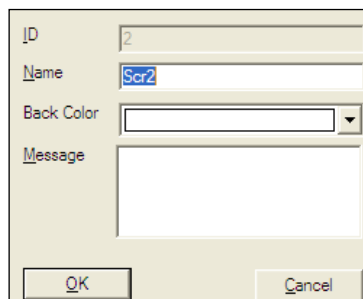
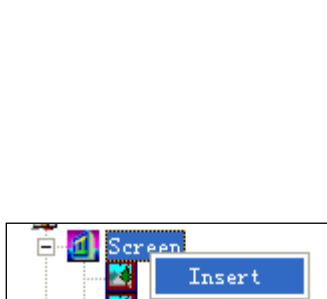

Step 2: password setting

Set the password follow the path”file/system setting\parameters”

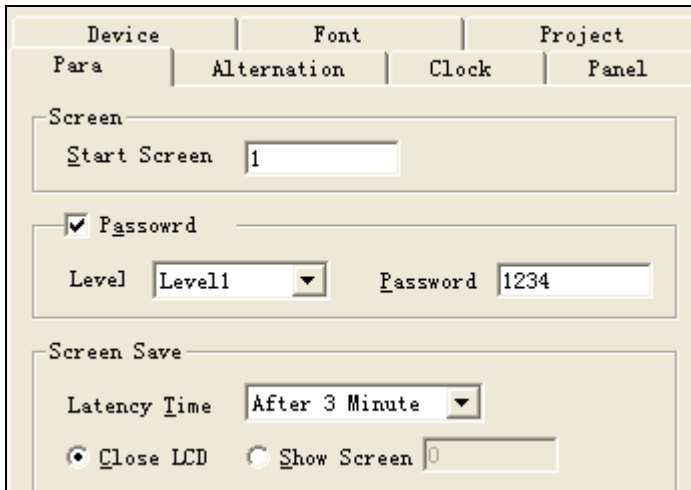

- Click “password”, choose the first level, enter “1234” as the first level password.

Thus, screen editing and password setting are finished.
 Investigate the run situation via emulator offline.
 When the password is correct, then jump into the next page

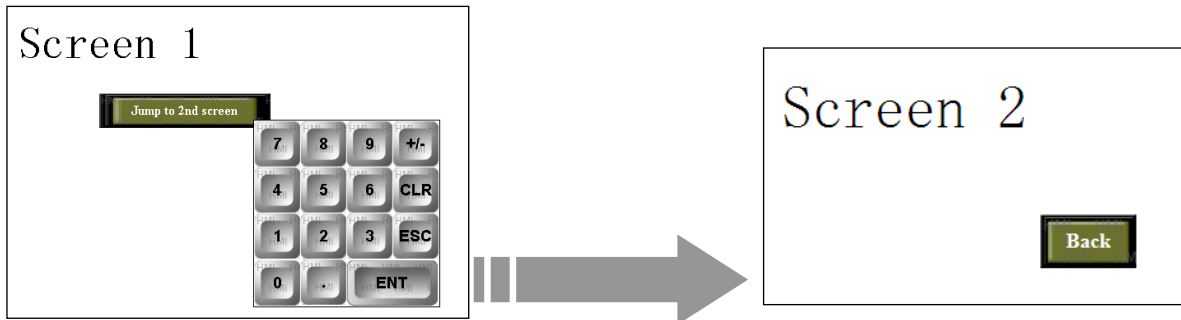

when the password is not correct, suggestive dialog box appears.

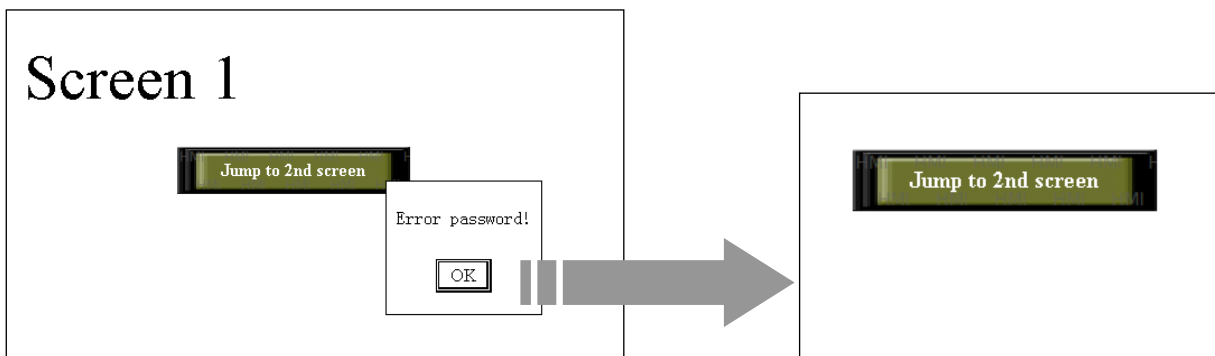

2.2.2 Indirect mode

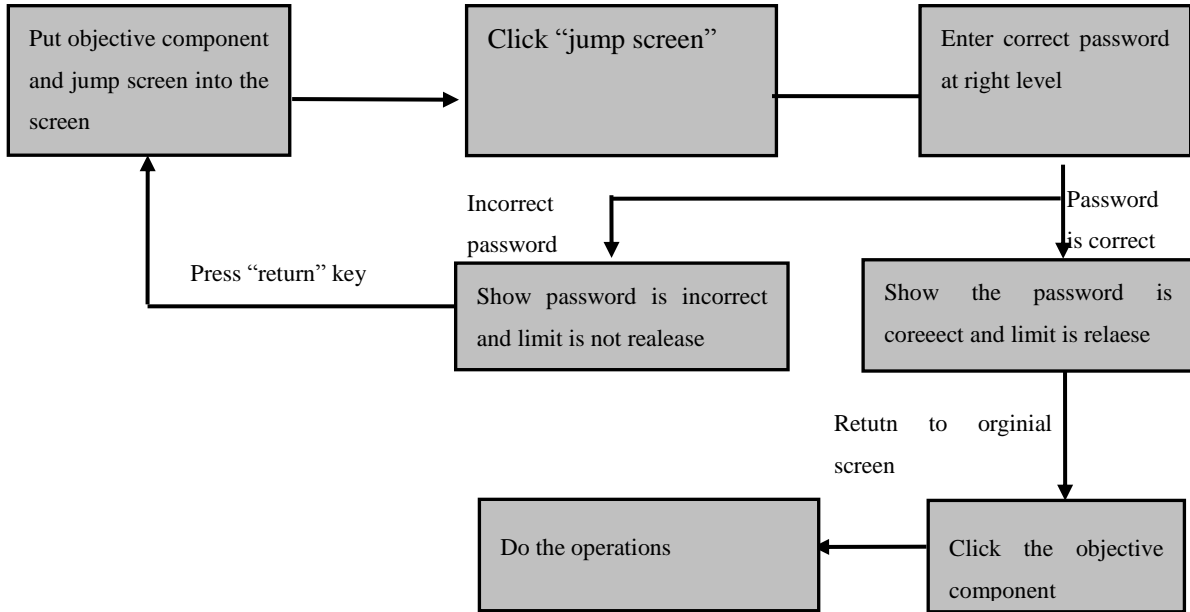

Release the password limiting by jumping into the password screen first, then do the objective operation. The procedure is shown as below:



Purpose:the objective component is not available until the limit is released.

Procedure

The procedure is comprised of screen editing and system setting.

Step1:Click component  and ,leave them to the objective position,shown as below



Set property of these two component.

Set the property "input" of "digital input"as below, others can be defined by users.

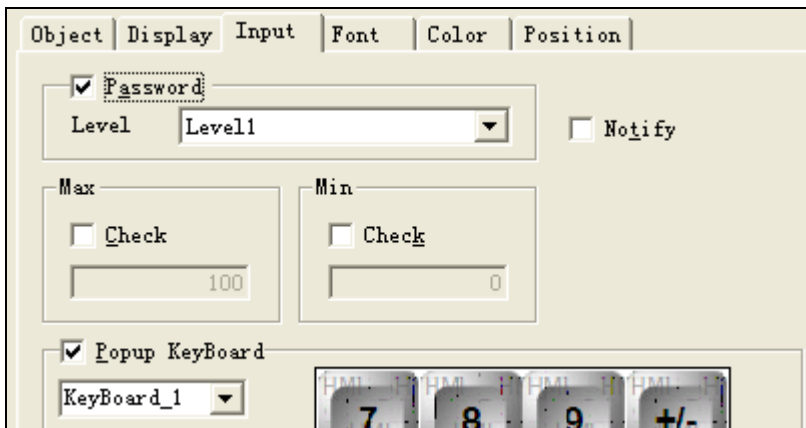

● Click the password at the first level.



More details regarding “digital input” please refer to introduction of component—digital input.

Set the property “operate” of “jump screen”,the other property can be defined by users.

- Set the screen ID on value “60001”,and this ID is the only active value
- Mode:log on
- Change the name to “enter password ”



More details regarding “jump screen” please refer to introduction of component“jump screen”.

Thus, the screen editing is finished.

Step2,set the system password

Set the password follow the path”file/system setting\parameters”

- Click the password with the first level,and set the password at the value”1234”

Investigate the run situations via emulating offline

We can see that the component “digital input ”is not available because of the limit.

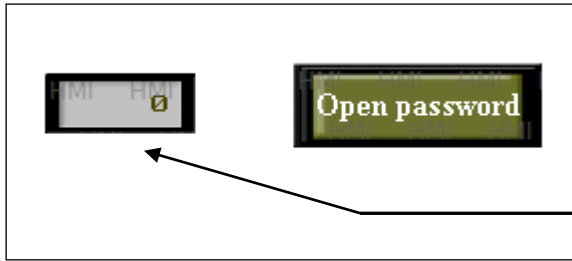

- Digital input is not available

Procedure

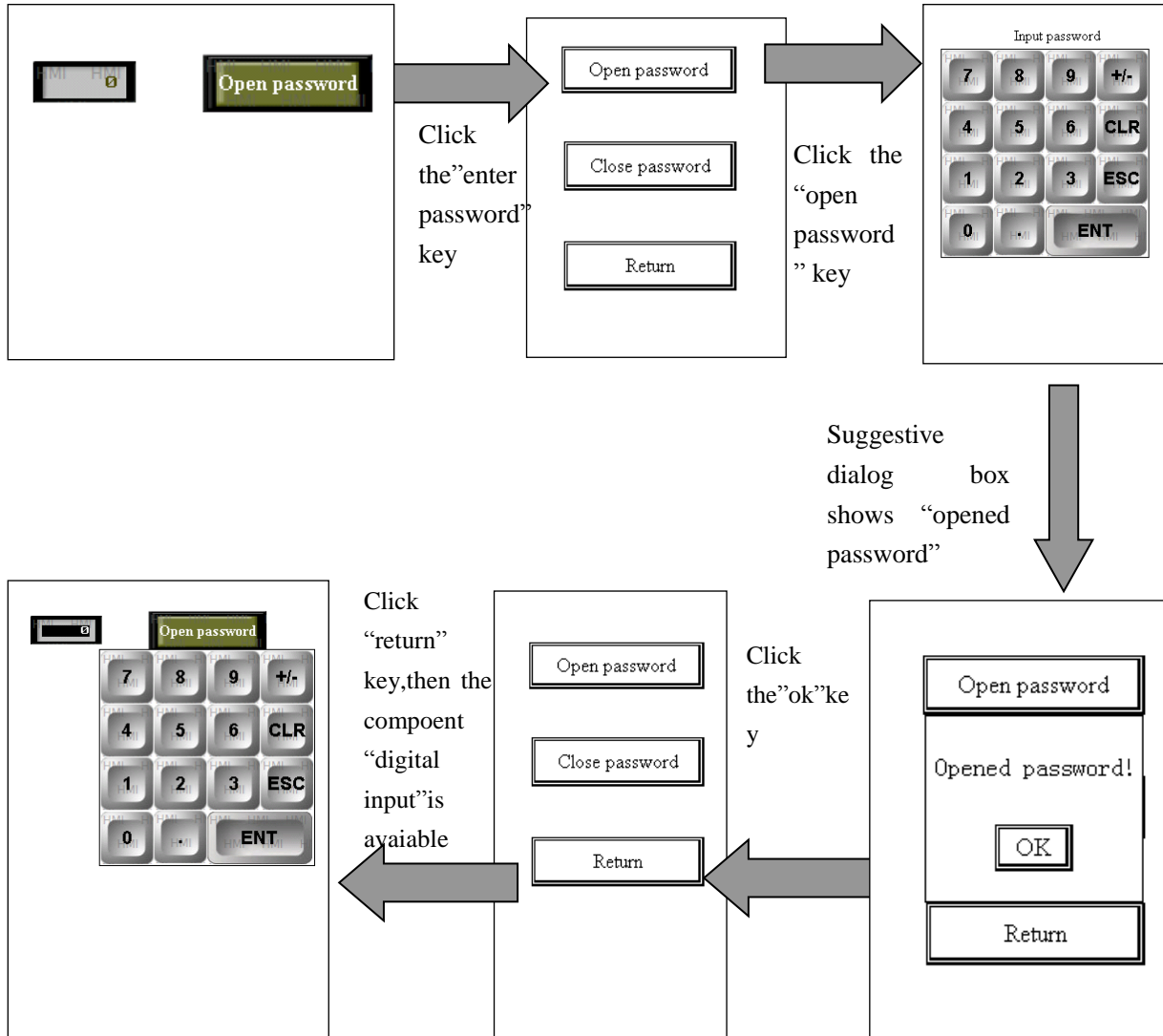

If the limit of the component is needed again, please jump into the “password screen” then close password, the protection is available again.

2.3 Note

Jump into “password screen”with ID60001 first to open password when you use indirect way with “validate mode”



The procedure regarding how to enter into advanced function mode please refer to the <HMI manual basic>

3 Print function

3.1 Introduction

Both TH series and TP series touch panels can connect with panel printers ,bringing good performance in the data operations ,such as “data collection”,”trend curve”and so on.

At present ,Touch panels can only connect with the following two brand printers.

- (1) **Sprt micro printers**
- (2) **Weihuang printers**

It is noted that there is defference in connection between TH series panels and TP series panels

- **connection between TH series panel and pinters**

Connect COM1 port of TH series panels to printers directly.

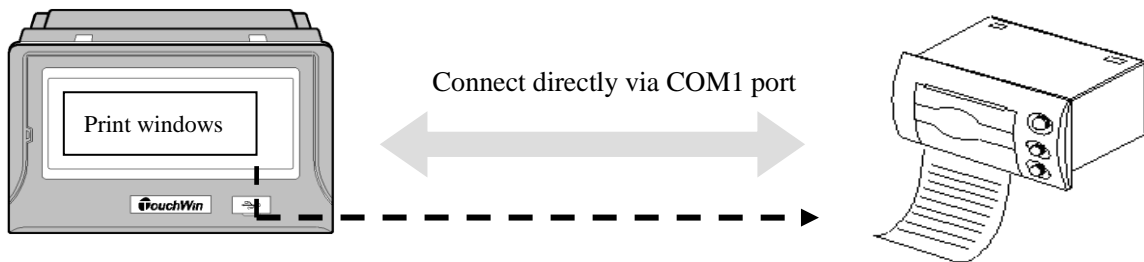

- **Connection between TP series panels and printers**

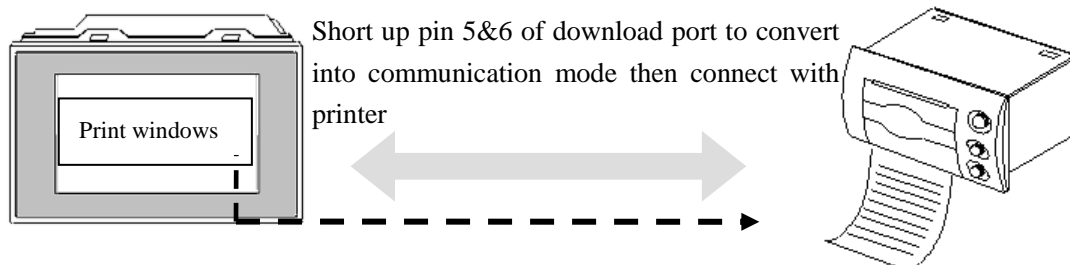

This charpter takes SPRT printer for example to describe how to arrange the printer function,the procedure is shown as below:

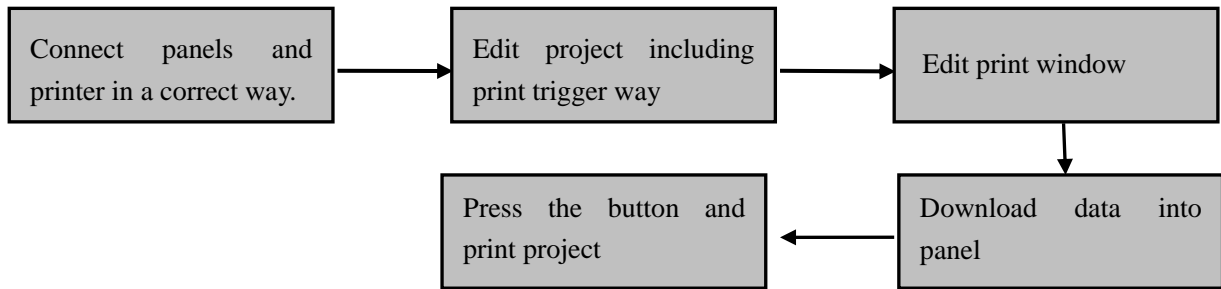

3.2 Procedure

3.2.1 Requirements

Purpose of this project is to record useful data bringing analyse advantage,including time, duty NO,operator's ID, product batch NO,and so on.

Thus ,the whole project is comprised of four sreens ,(1) operators information (2) print window,(3) 2 process control information

- (1) Component comprising operators information: duty NO,opertaor ID,batch NO, jump screen
- (2) Component comprising Print window:Date,time,dutyNO,operator ID,batch NO,batch NO .
- (3) Component compring process control information:composed of heat up and leak hunting, record date ,time,temperaature,pressure and value of F0.

Structure of project is shown as below:

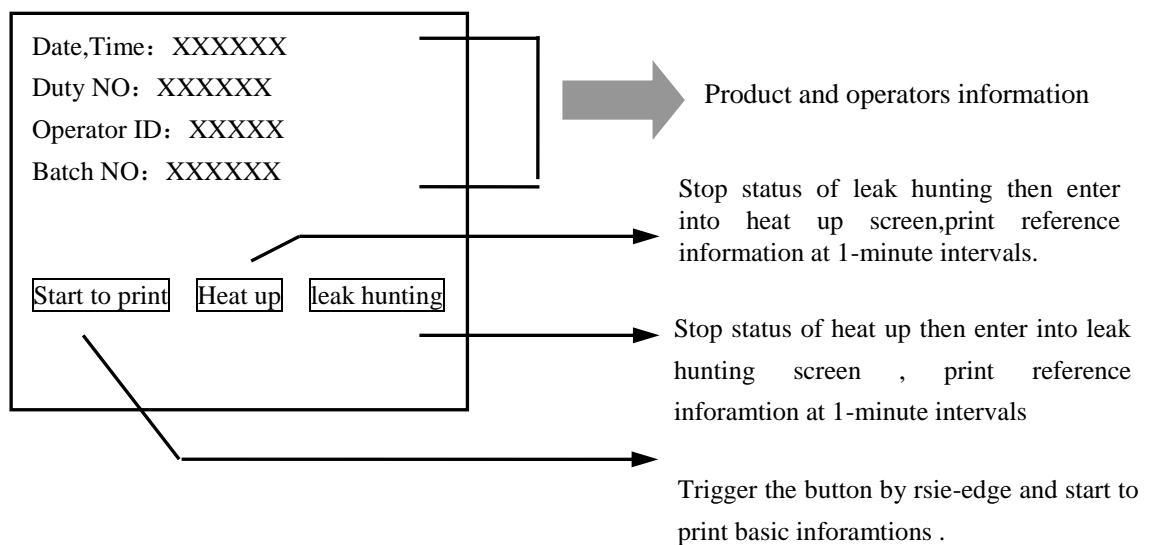

3.2.2 Preparation

Hardware preparation

- (1) TP series panels with type TP562-T
- (2) Sprt DNseries printer with type SP-RMIII32SH
- (3) Version of editing software is V2.87 or above
- (4) Download cable used for TP, communication cable bewteen panels and PLC.
- (5) Printout paper:57.5mm thermal printer paper

Document preparation:Sprt printer user manual

3.2.3 Connection

The following take SP-RMIII32SH (DN series) for example to describes connection.

- (1) **For TH series panels, connect to printer with COM1 port directly.**

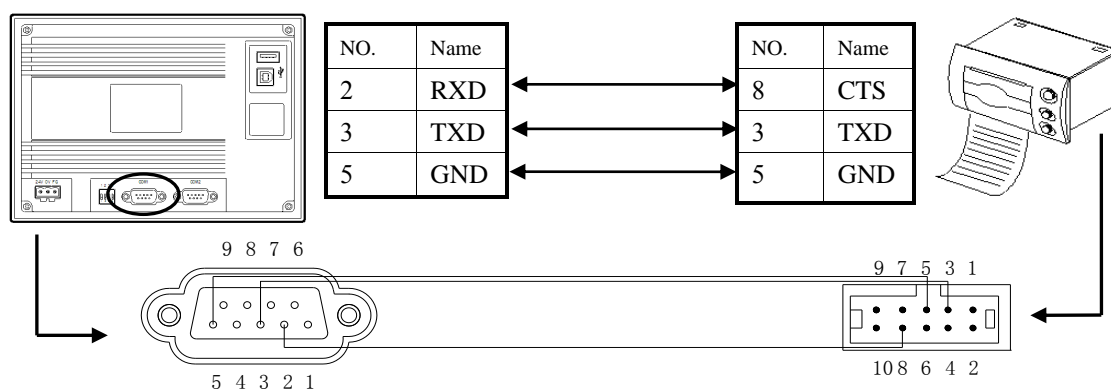

- (2) **For TP series panels, please short up 5 pin and 6pin of download port first, then connect with printer.**

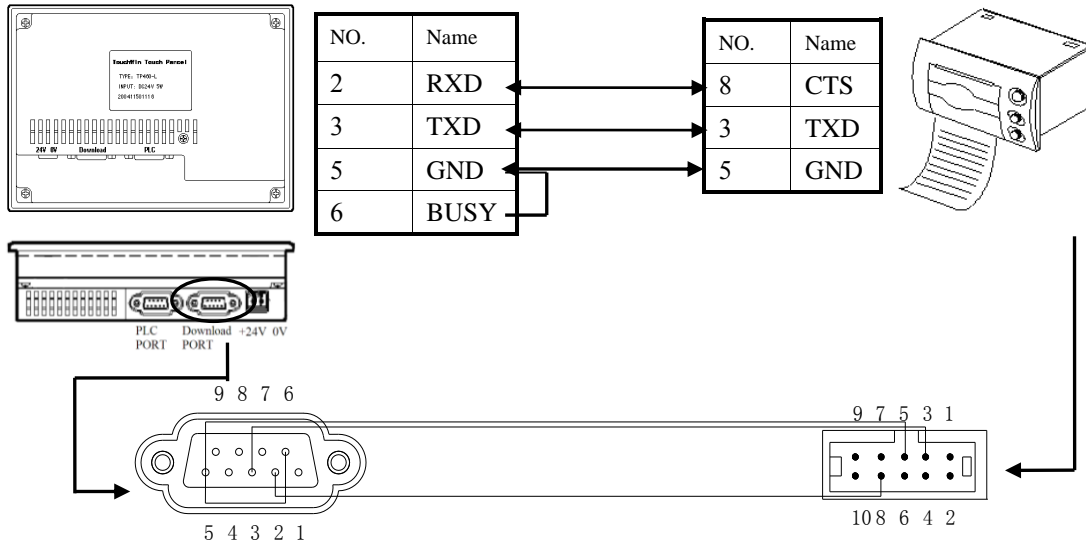

➤ **Setting on printer**

Setting cummication paramters

Baudrate: 9600

Parity check: even

Handshake:random

DIP swithes status: turns 1 and 6 ON,others are OFF, showed right



3.2.4 Project editing

As above ,the whole project is compried of 4 screens :(1) operators information (2) print window,(3) heating process control information(4)leak hunting process control inforamtion.There are 3 registers and 3 coils used for this print project,assignment is showed as below

Name	Register	Description
Duty NO.	PFW300	Digital input and display
Operator ID	PFW301	Digital input and display
Batch NO	PFW302	Digital input and display

Name	Coil	Description
Start to print	PSB300	Print out
Convert to “heat up” mode	PSB301	Print out in this mode
Convert to “leak hunting” mode	PSB302	Print out in this mode
Print during heating up process	PSB303	Trigger action to print
Print during“leak hunting process	PSB304	Trigger action to print

- Operators information (main screen)

Step1,insert a new screen,set the parameters of PLC port and Download port.

Insert a new screen as path”file/new”or click component  from toolbar, choose panel type with TP562-T, then set the parameters of PLC port and Download port, showed as below:

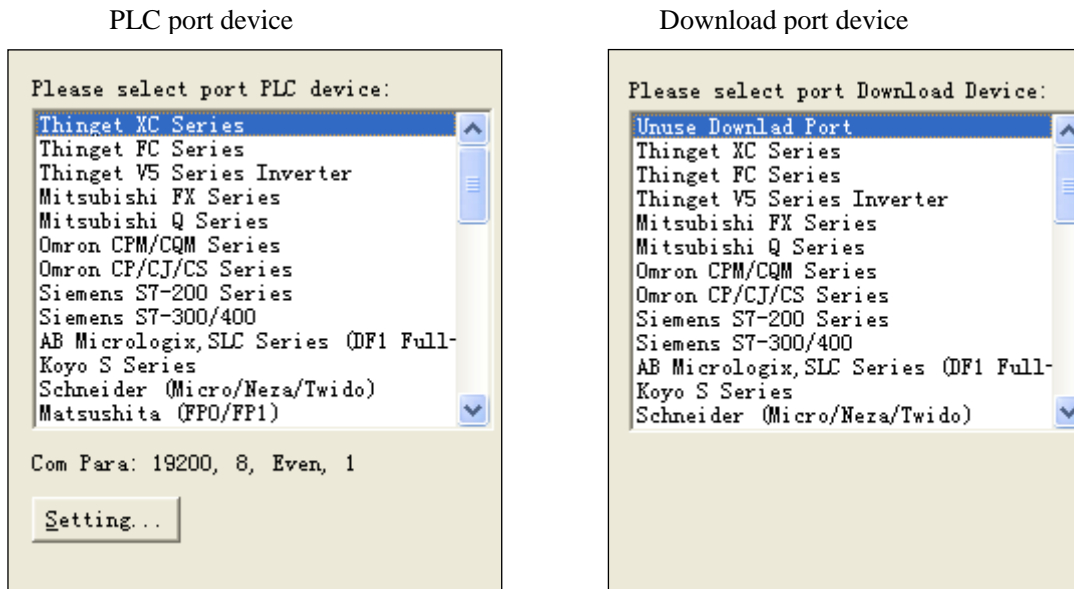

Step2 ,add these component into main screen,Text  ,digital input  ,button  ,”button+function field”

 , date  , time  , is showed as below:

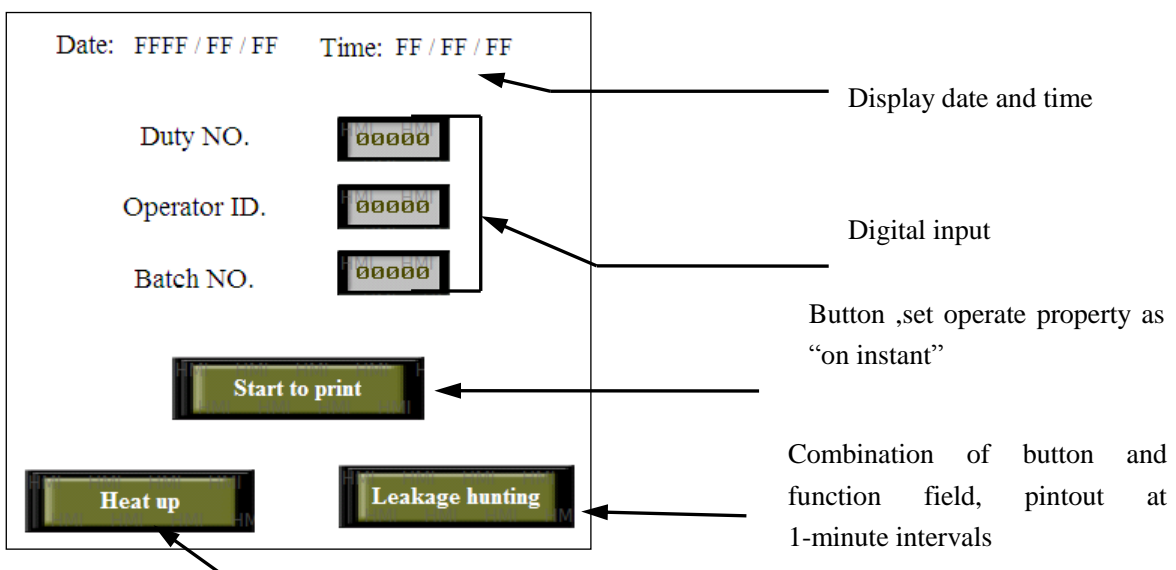

Property of “digital input”

Set the operate object based on the sequence of “duty NO—PFW300, operator ID—PFW301, batch NO—PFW302.” as follows

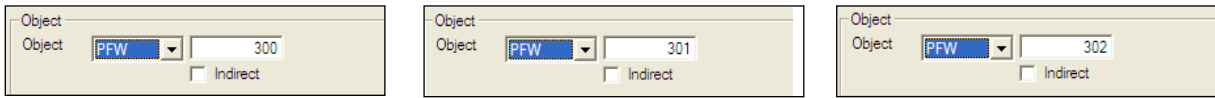

More details about “Display”input”,”Font”,”color””position”please refer to “components——digital inout “parts”

Property of “button”

Set the objet to PSB300, and operate as ON instant

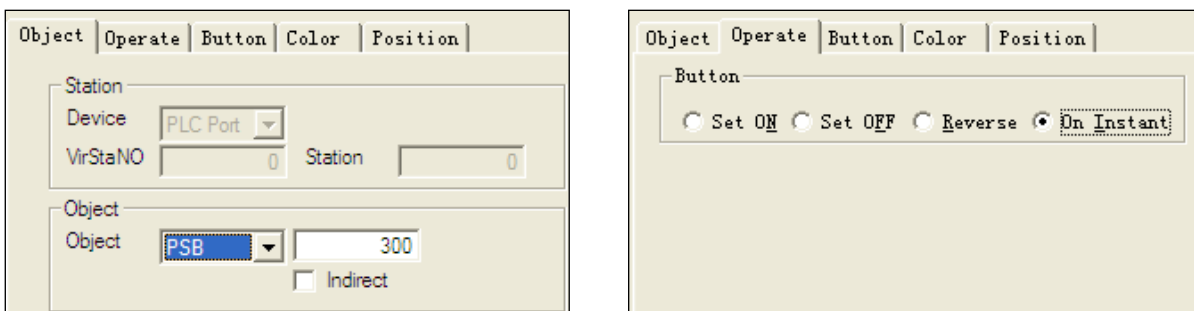

More details about “button”,”color””position”please refer to “components——button,parts

Property of “button+function field”

Press “button”key to enter “heating up”or “leakhunting”status,at same time, “function feild ”is active leading to set on/off appointed coil regularly.

For example, when coil PSB301 is ON, screen enter into status of “heating up”, meanwhile,the function field is active leading coil PSB303 to be off,and convert coil PSB303status between On and Off at regular intervals.

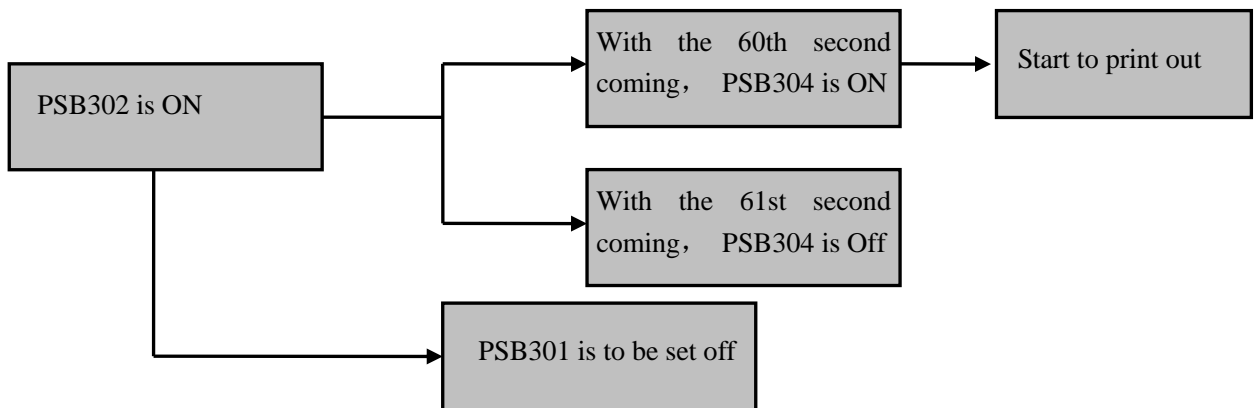

PSB302 (leak hunting) work’s procedure

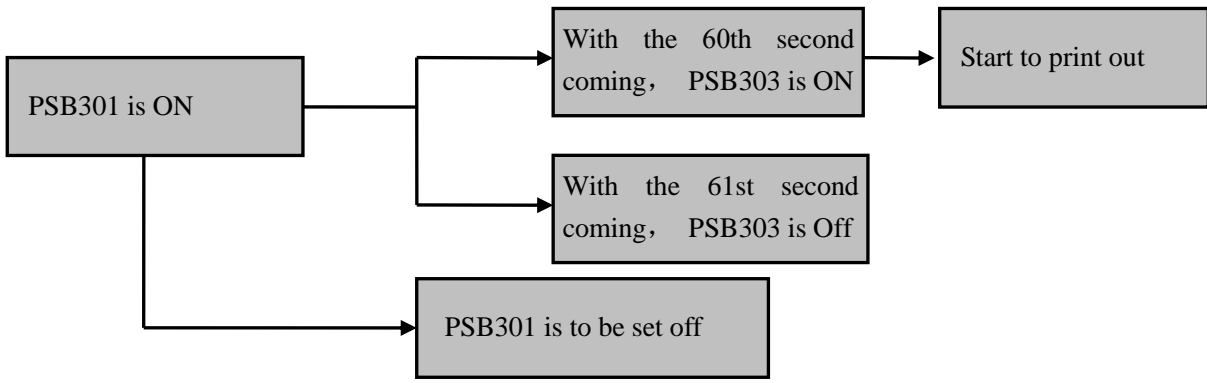

PSB301 (leak hunting) work's procedure

Assignment of the above component

Print out during heating up process			Print out during leak hunting process		
Component	Qty	Function	Component	Qty	Function
Button	1	PSB301 is ON	Button	1	PSB302 is ON
Function feild	3	PSB302 is OFF	Function feild	3	PSB301 is OFF
		With the 60th second coming, PSB303 is ON			With the 60th second coming, PSB304 is ON
		With the 61st second coming, PSB303 is Off			With the 61st second coming, PSB304 is Off

The following charpter describes how to set property of “button”and “function field”,

Setting property of “button”

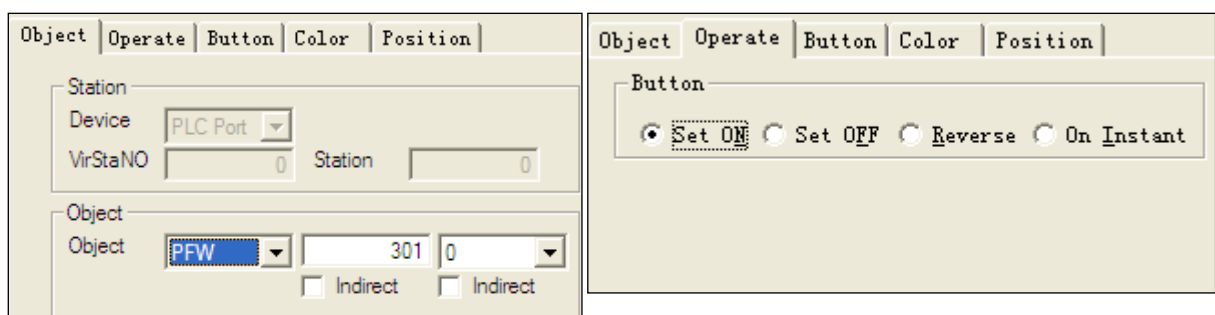

(2) setting property of “function field ”

- Trigger PSB301 to set PSB302 off by using “function feild”

Click component  from toolbar ,then set the property ”mode”setting

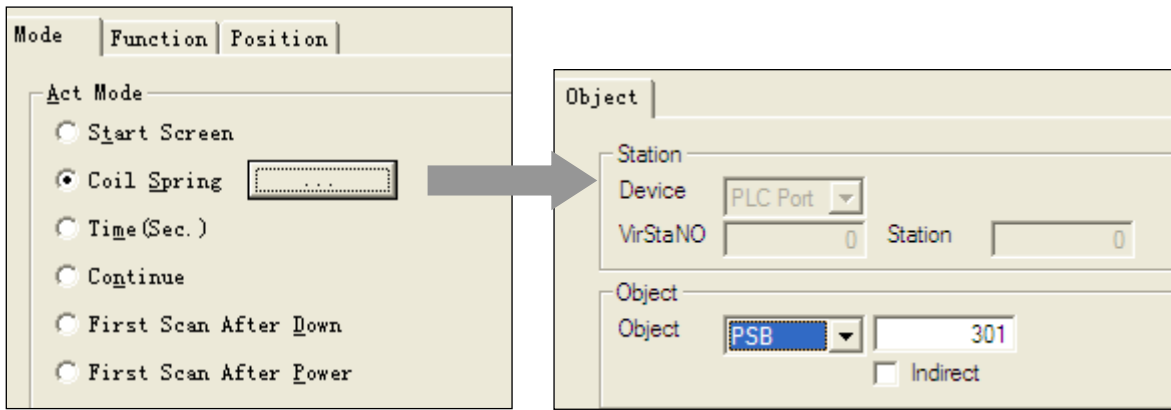

function setting, reset coil PSB302

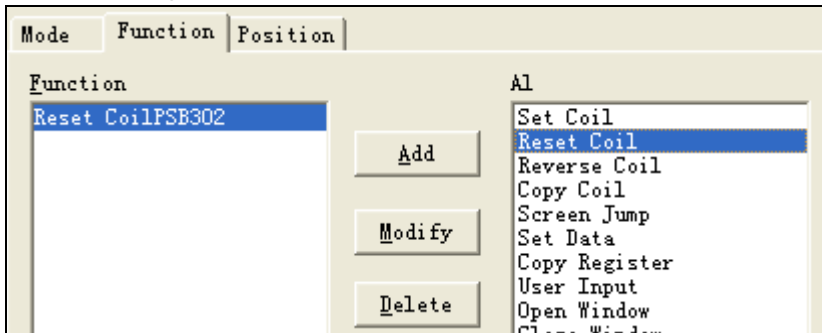

- Trigger PSB301 to set coil PSB303 by using “function feild”

”mode”setting,set intervals value

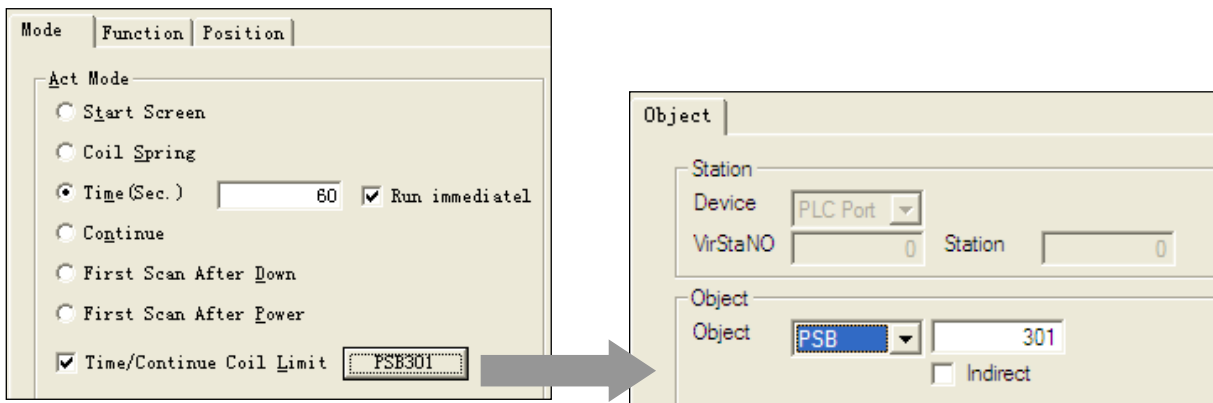

function setting,set coil and start to printout

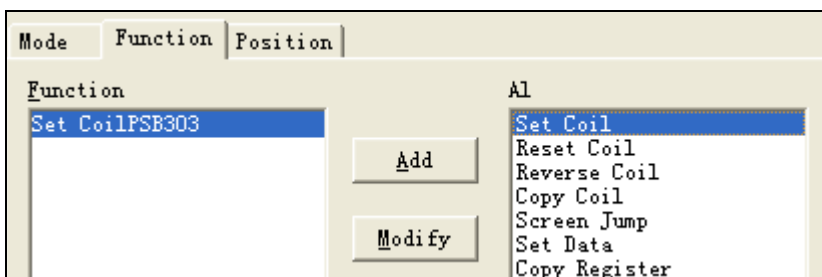

- **Trigger PSB301 to reset coil PSB303 by using “function feild”**

mode setting, set intervals value

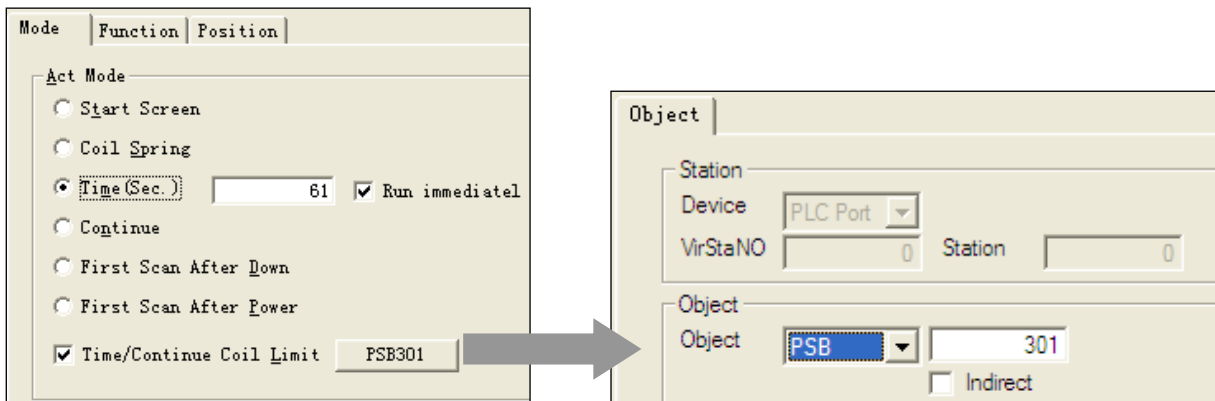

function setting, set coil and start to printout

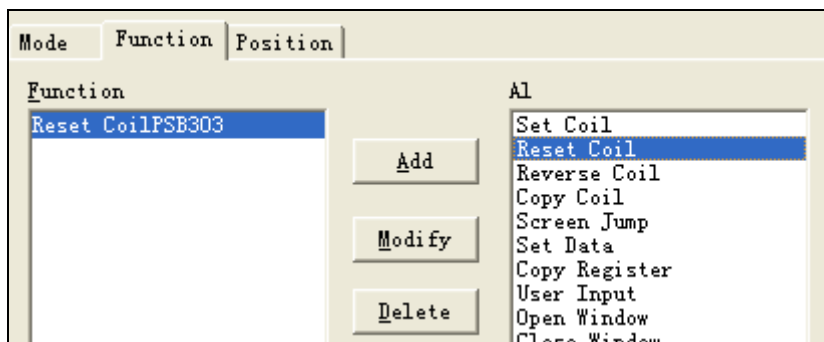

thus ,all setting of “heat up”is finished



regarding the setting of “leak hunting” please refer to procedure of “heating up”

The main screen is showed as below

Date: FFFF / FF / FF Time: FF / FF / FF

Duty NO.

Operator ID.

Batch NO.

Start to print

Heat up **Leakage hunting**

Function Field Function Field
 Function Field Function Field
 Function Field Function Field

● Print window for basic informations



Right click “print” in engineering bar and choose “insert”, set property as below:

Object | Print Window |

Station

Device

VirStaNO Station

Object

Object

Indirect

Object | Print Window |

Window

Name Width

Tip Height

Director

Left to Right Right to Left

Object property: start printout by coil PSB300 triggering.

Print window: print direction is from right to left with name “start to print”



Note

Make sure the print direction is from right to left while use this function.

(2) Project editing

Click these components from toolbar, "text"  "digital display"  "date"  "time" , as shown

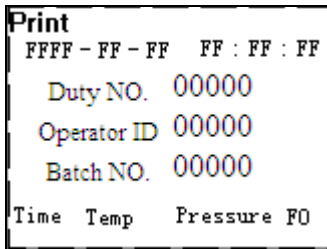

- Duty NO is in PFW300
- Operator ID is in PFW301
- Batch NO. Is in PFW302

● Process control screens ,including “heating up ” and “leak hunting”,

➤ **Printout during “heating up”process at 1-mintue intervals**

Procedure details please refer to the above chapters ,the setting is showed as below:

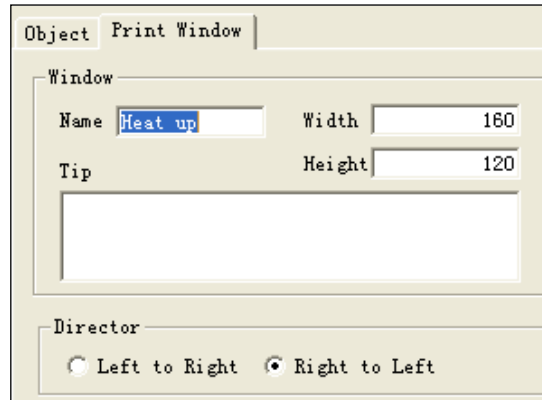
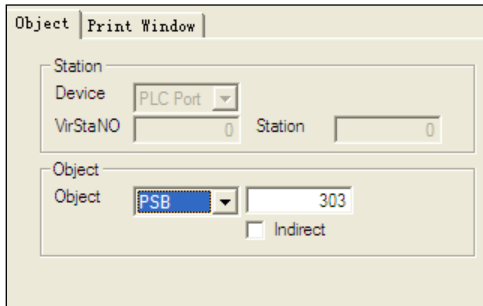

The print window is showed as below:

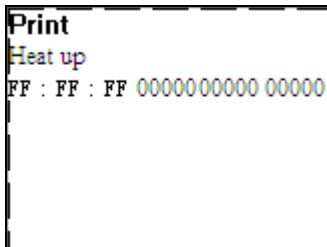

- Temperature is in PFW303;
- Pressure is in PFW304;
- F0 is in PFW305
- Take a suitable size to save up papers

➤ **Printout during “leak hunting”process at 1-mintue intervals**

Procedure details please refer to the above chapters ,the setting is showed as below:

```

Print
Leakage hunting
FF : FF : FF 00000 00000 00000

```

- Temperature is in PFW303;
- Pressure is in PFW304;
- F0 is in PFW305
- Take a suitable size to save up papers

3.3 Notes

- (1) Print direction:from right to left
- (2) Coil used to trigger printing : For manual operation, it is advised to use coil after PSB257;for controlled by PLC, it is advised to use auxiliary coil M, and keeping on about 3 seconds.
- (3) Make sure all components is in range of print window ,otherwise , it will print unsuccessfully.
- (4) Don't copy the print window to others to avoid print twice.

4 Dual port communication

4.1 Introduction

Both TP series panels and TH series panels support Dual port communication function, which means not only Download port can connect with devices but also PLC port does. With independent data transmission, this system has a perfect performance based on one-panel & two-devices structure.

Communication structure is shown as below:

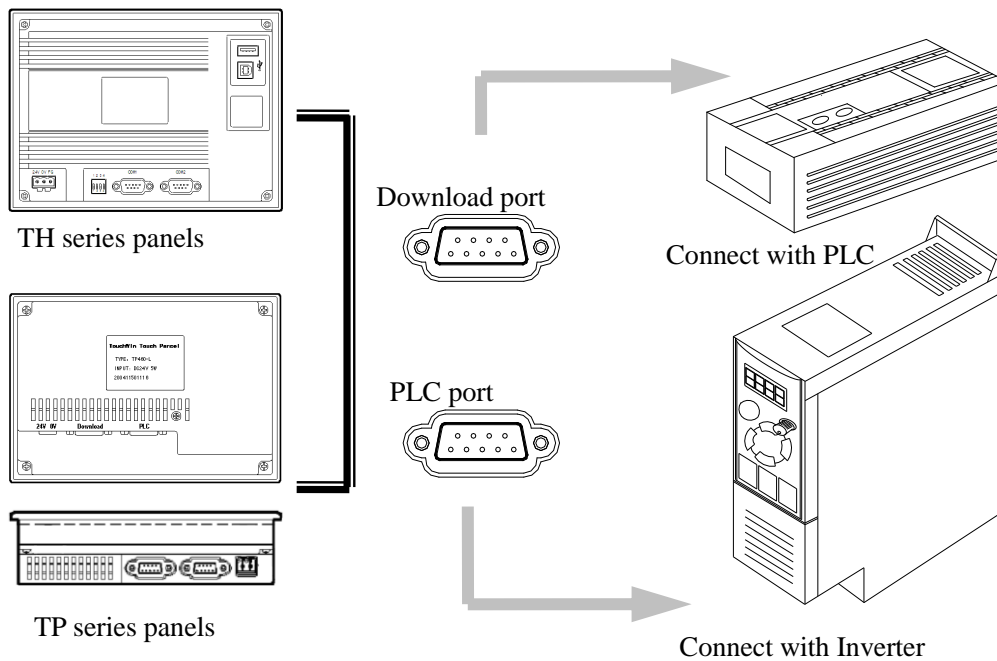

4.2 Procedure

This chapter takes an example to describe how to use the function with the download port connected to a PLC while the PLC port is connected to an inverter.

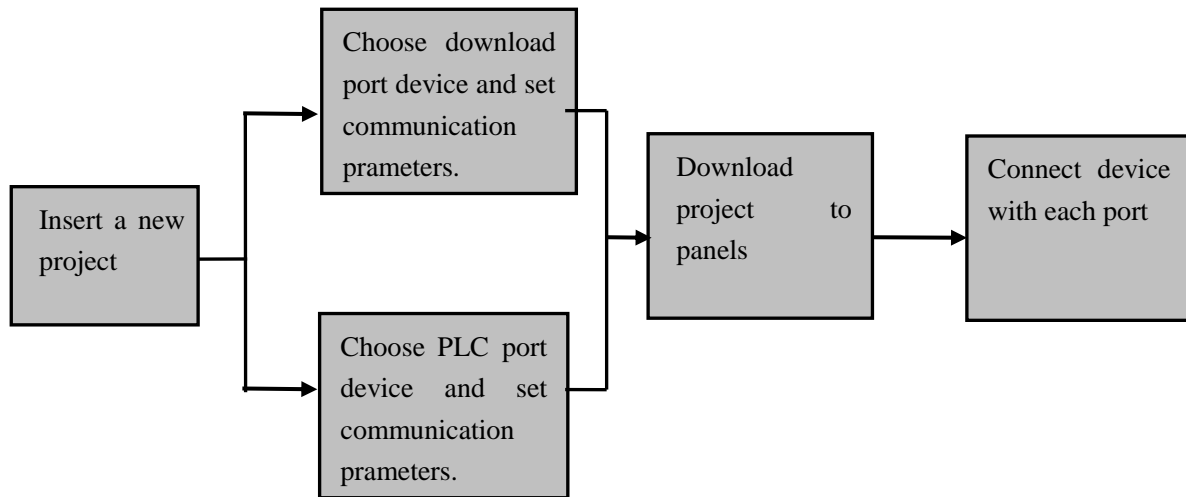

4.2.1 Requirements

- (1) Connect to PLC with Download port, controlling and indicating PLC output Y2.
- (2) Connect to Inverter with PLC port ,do the operations including start ,stop and frequency setting .

4.2.2 Preparation

- (1) TH series panels with type TH765-MT;
- (2) XC3 series PLCs with type XC3-32R-E;
- (3) V5series Inverters with type V5-21P5
- (4) Software version is above Twin V2.C.3
- (5) Download cable used for panel, Download cable used for panel used for PLC,communication cable between panels and PLC, RS485communication cable.

4.2.3 Project editing

The procedure of project editing is comprised of new project open and component editing, is showed as below:

Step1:open a new project,set parameters as below:

Insert a new project as path"ffile/new"or click component  from toolbar,is showed as below:

Select PLC port device with V5 series inverters

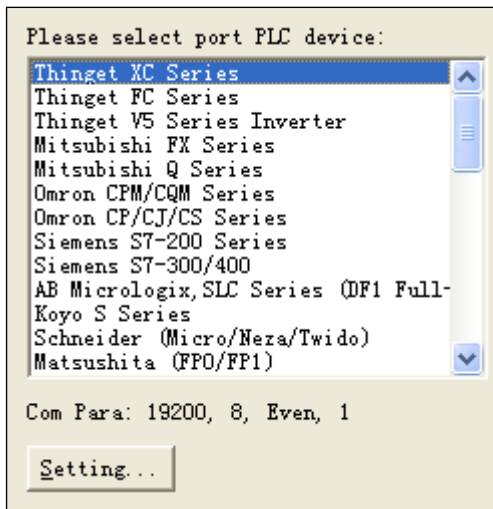



Select XC port device with XC series PLC



Step 2:edit the control screens including PLC and inverters

- (1) Connect Download port to PLC(XC3-32R-E) to control output Y2 with “button ”component and indicate status with indicator light.

Click the component “button”  indicator light  from toolbar, set property as below:

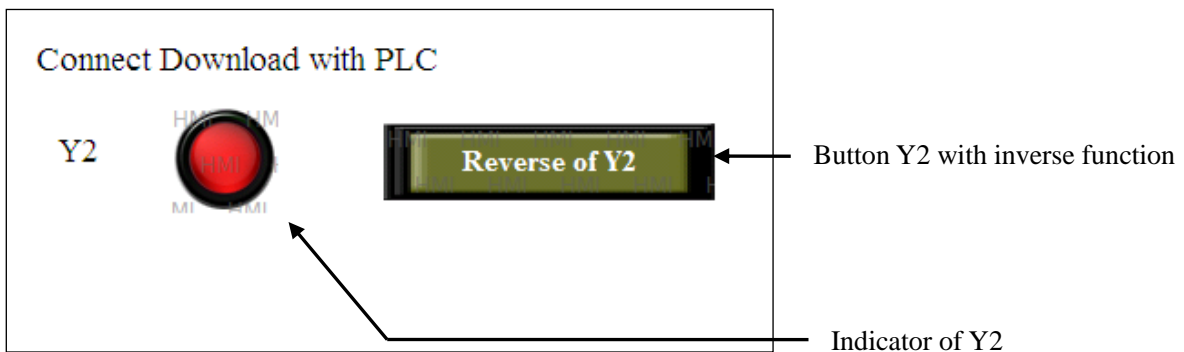

Property of indicator

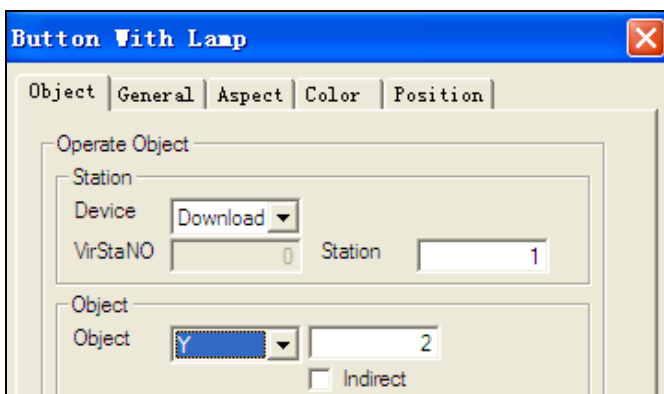

- Station NO: select connection device via download port.
- Object : select to Y2

Property of button

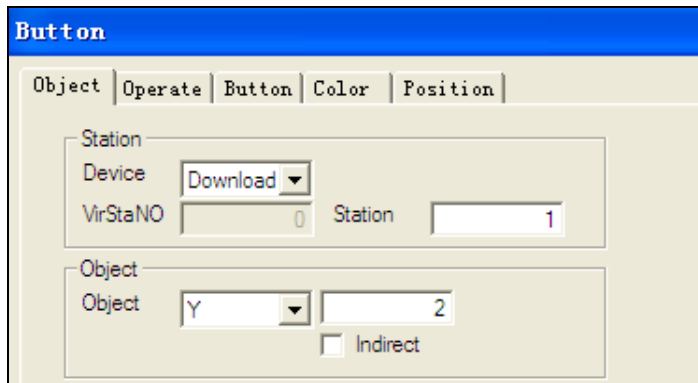

- Station NO : select connection device via download port.
- Object : select to Y2

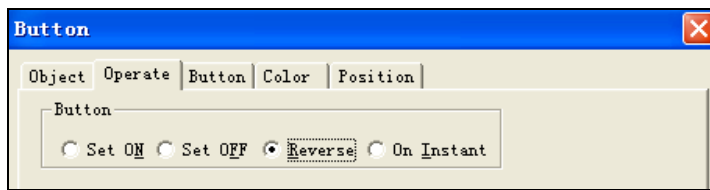

- Operate :inverse

(2) Connect V5 inverter with PLC port ,achieve operation including start ,stop, frequency setting,frequency indication.

Click “digital input ””digital indicator ””lamp button ” and leave it in objective position editing project is showed as below

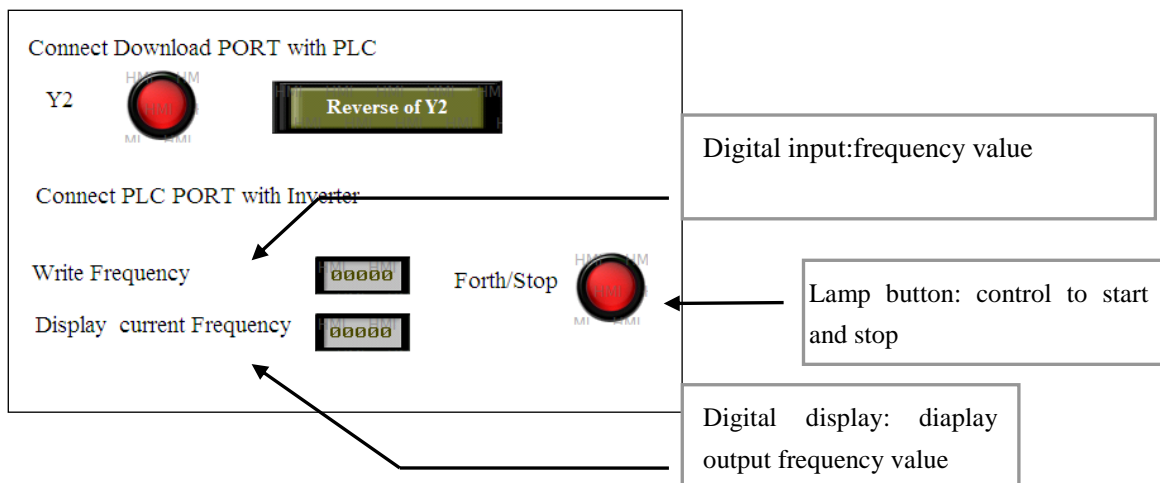

Property of digital input

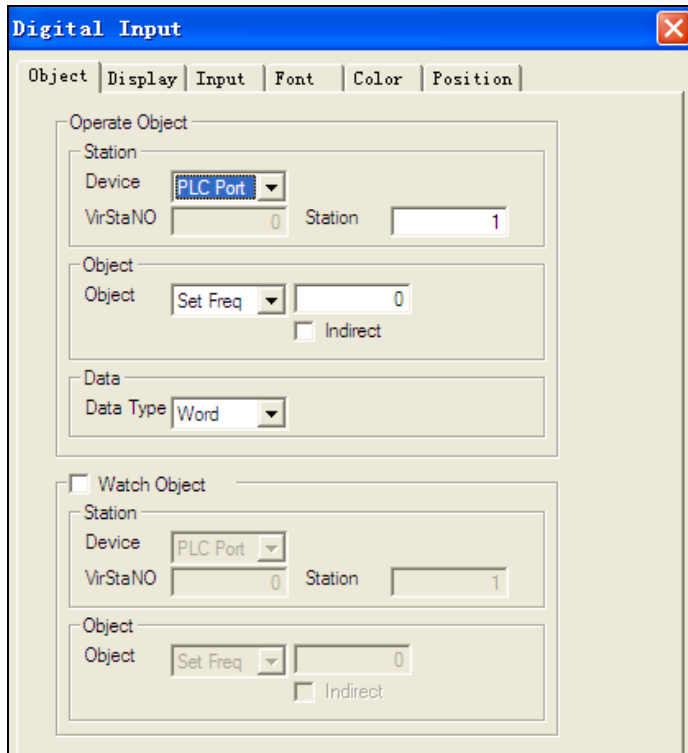

- Station :
Station No: select PLC port and set PLC No as 1

- Object :select"set frequency"

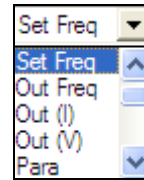

,then enter right address

Property of Digital display:

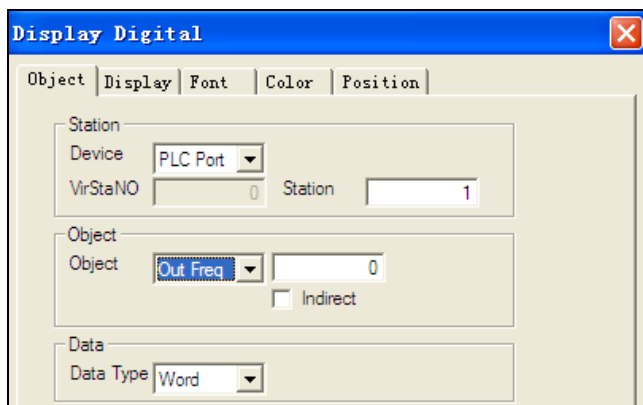

- Station

Device: select PLC port with station NO1

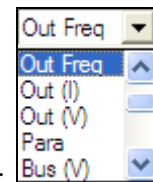

- Object: , select "output frequency"and enter right address

- Data type is with default value:Word

Property of "lamp button"

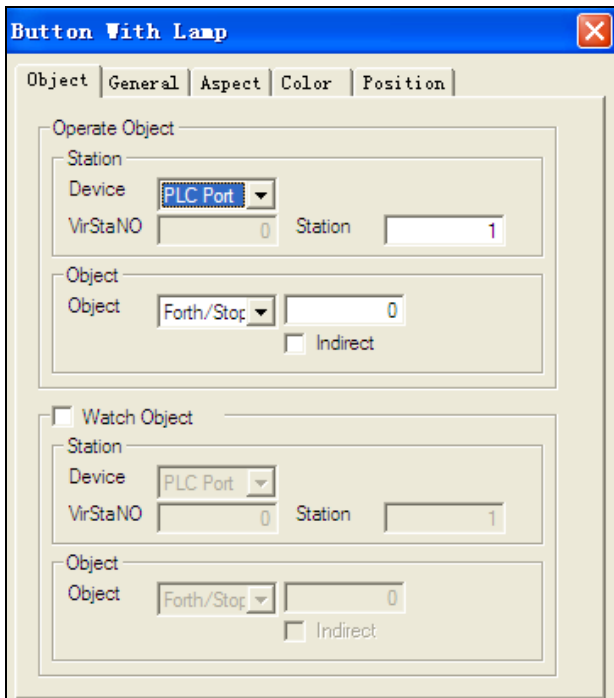

- Station
Device: select PLC port with station NO1

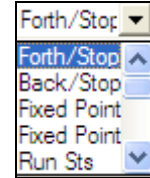

- object : select "foth/stop" and enter right address.

Thus, the editing project is finished, please use original cable to download data, the project is shown as below

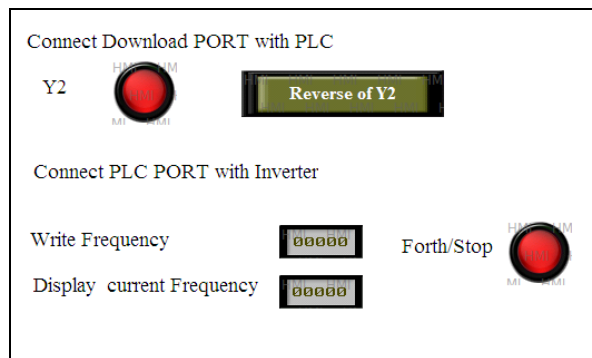

Regarding how to download data please refer to "open a new project" for more details

● Connection

Do the following connections and parameter settings, PLC with download port and inverter with PLC port.

(1) Parameter settings for connection between Download port and PLC

In this example, take PLC type with XC3-32R-E then choose port 2, as below:

Name	Setting value	Note
Modbus station NO	1	Default setting
Baudrate	19200	
Data bit	8	

Stop bit	1	
Parity check	Even	

B Set the download parameters of TH765-MT as same as PLC

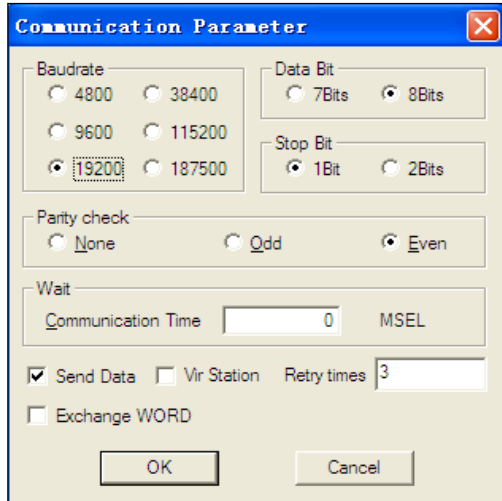

- Parameter setting:
Baudrate: 19200;
Data bit: 8;
Stop bit: 1;
Parity check: Even;



More details regarding parameters setting of PLC please refer to the XC series PLCS manual, can get from Xinje website "www.xinje.com"

(2) Parameter settings for connection between PLC port and inverter

A Parameter setting for Inverters

Set the parameters of V5-411P5

Name	Setting	Description
P0.01	Frequency selection 4 given	Controlled by communication
P0.03	Run command selection 2	Controlled by communication
P3.09	Communication parameters setting 054	19200bps, 1-8-1, even
P3.10	Station No.	Same as panel's setting ,1

B Parameters setting of panel's PLC port:

Set the download parameters of TH765-MT as same as PLC

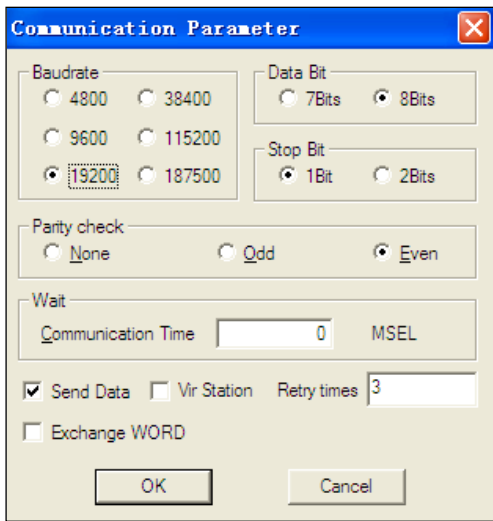

- Parameter setting:
 Baudrate: 19200;
 Data bit: 8;
 Stop bit: 1;
 Parity check: Even;

(3) Cable connection

A Connect download port to PLC with original cable or user defined cable, as below:

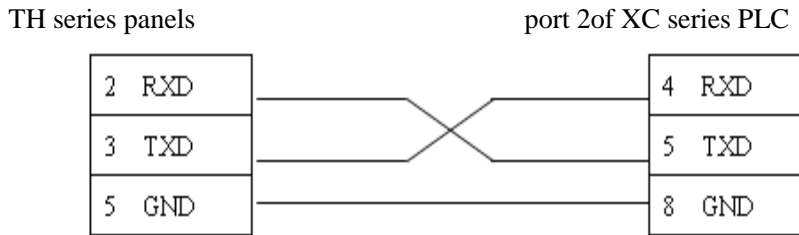

B Connect PLC port to Inverter with communication cable RS485, as below

PLC port of TH series panels

Terminals of inverter

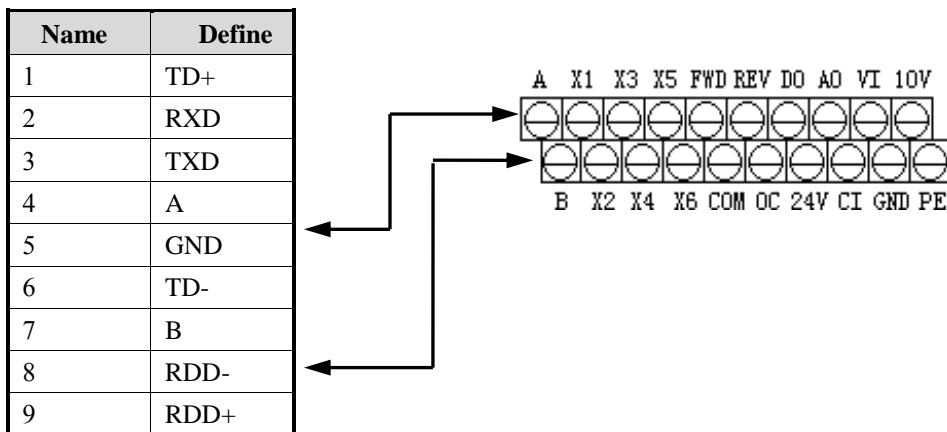

Turn on the power of system after confirming all the connections and settings ,debugging step by step with the operations of panels until it have a good performance.

4.3 Note

It is important to note the difference between TH series panels and TP series panels ,with default value, COM1 port of TH panels is in communication mode ,but COM1 port of TP series panels is used for download,please short up 5&6 PIN before it enter into communication mode.

5 Alarm list

5.1 Introduction

Display alarm information when a problem occurs , usually matched with 'text,dynamic text,digital display,event button' components.

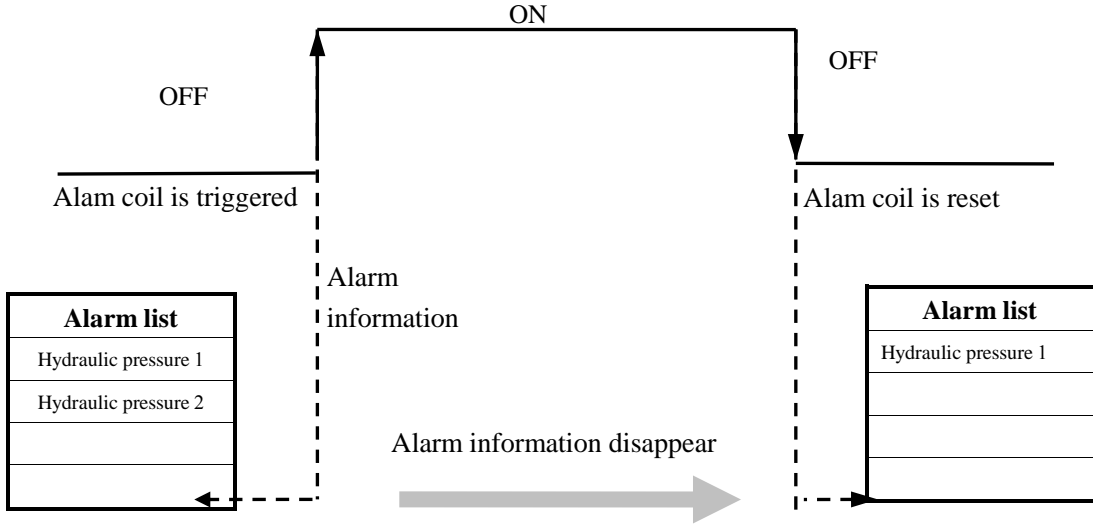

When coil M0 is triggered,display alarm information;
 When M0 is reset ,alarm information disappears.

5.2 Procedure

Step1; click the component  from toolbar and leave it to the objective position,is showed as below:

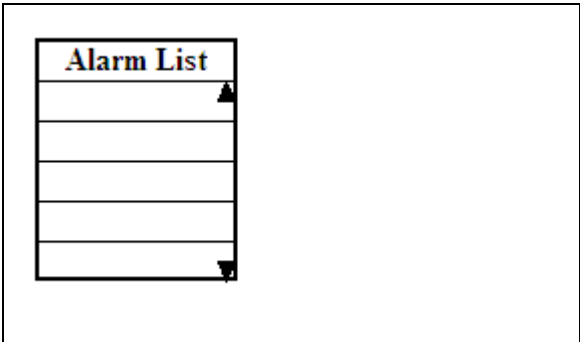

- Change the size via boundary point

Step2: set property ,including 'common,alarm,font and position' items

property of 'common'

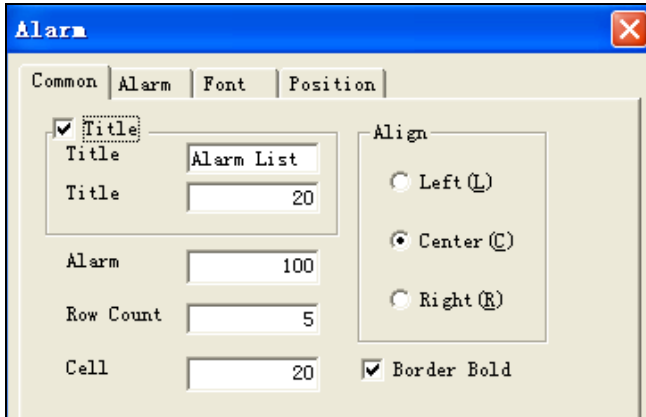

- Title:alarm list is showed with title,the width can be set.
- Align : select the align mode

property of 'alarm'

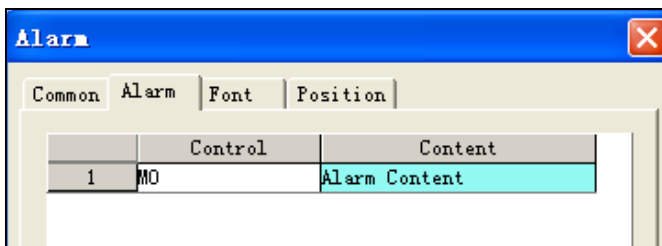

- Control coil: coil used to trigger the alarm
- Content : display alarm information

Alarm message adding or deleting

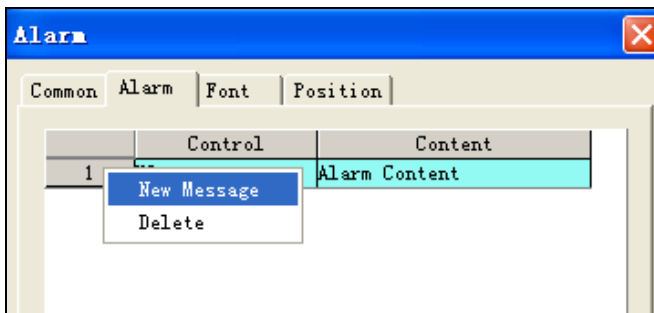

- Move to the NO. Position and right-click to select 'new message' or 'delete'.

How to do the operations with 'new text,new data and delete'

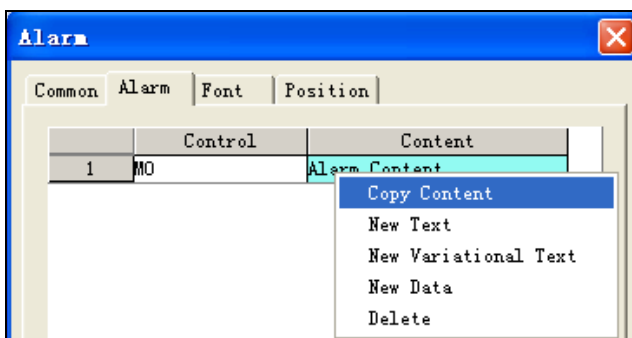

- Move to the 'content' position.
- Copy content: copy the content to another place.
- Paste content: paste the objective content
- New context: add new content
- New variational text: add variational text .
- New data:add new data
- Delete: delete the content

Details of above is showed as below:

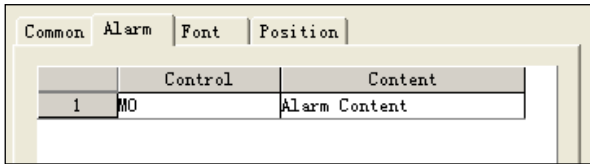

- Content is shown as left when “new content ”is selected

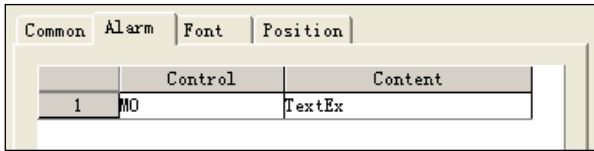

- Content is shown as left when ‘variational text’is selected.

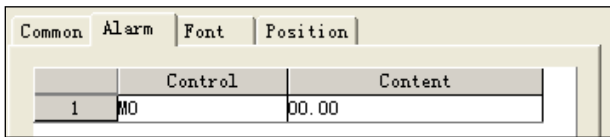

- Content is shown as left when ‘new data’is selected.



More details regarding ‘font ,position’please refer to ‘button’part.

5.3 Samples

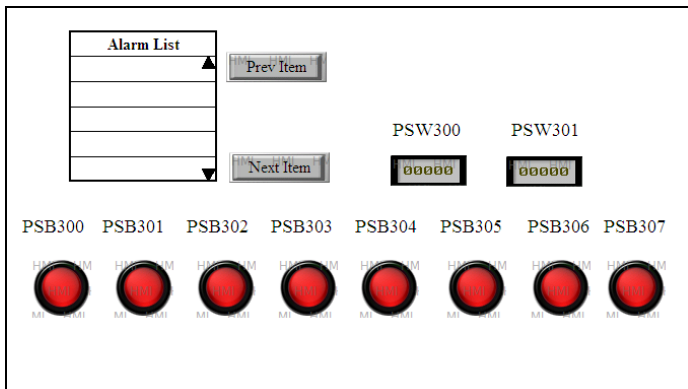

- In this example, alarm information is triggered by bit PSB300-PSB307,meanwhile the ‘variational text ’is based on value of register PSW300 and ‘data’ is according to register PSW301.
- Matched with ‘event button’,Alarm list can show more information.

The whole procedure can be comprised of 4 steps ,is showed as below:

Name	Property	Description
Alarm list	Display text	Show fluid level
	Display variational text	Show content based on register value
	Display data	Data indicator
Event button	Prev item,next item	
Digital input	PSW300、 PSW301;	Data input
Lamp button	8 lamp button from PSB300 to PSB307;	Trigger and reset alarm inforamation

5.3.1 'Alarm list' editing

Click component  from toolbar and set 'alarm' property as below:

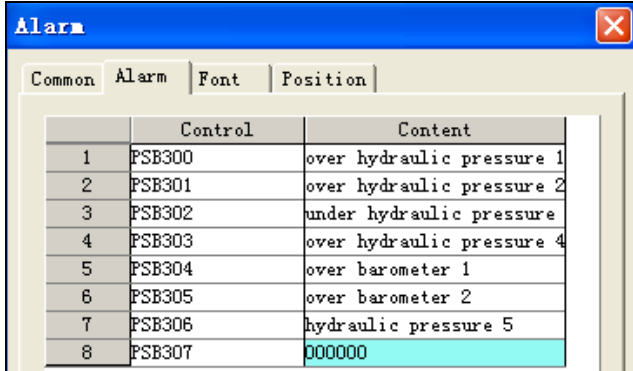

- Add new messages to 8 items, from 1 to 6 are text, double-click to set property as below:

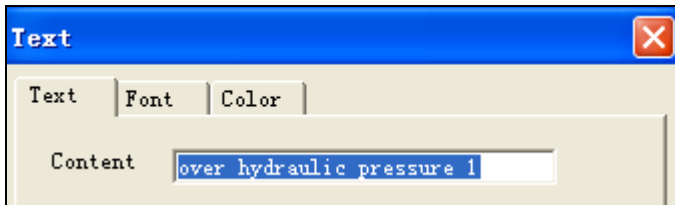

- Alarm message triggered by PSB306 is referenced with PSW300, double-click this item TextEx, its property is shown as below:

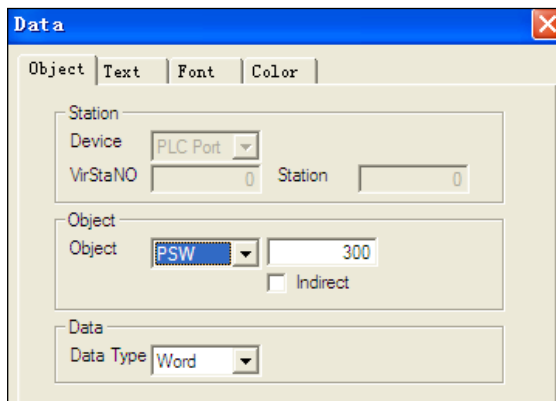

- Select the object with register PSW300

'Display' property:

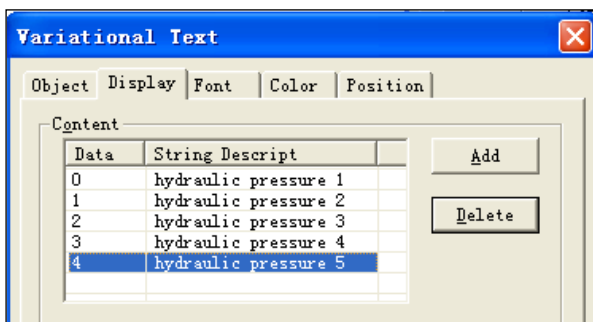

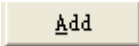
Add new message via button 

The contact between PSW300 and alarm information is showed as below:

Value	Alarm message
PSW300=0	Hydraulic pressure 1
PSW300=1	Hydraulic pressure 2
PSW300=2	Hydraulic pressure 3
PSW300=3	Hydraulic pressure 4
PSW300=4	Hydraulic pressure 5

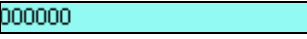
- The alarm message triggered by PSB307 displays data, double-click  to set property as below:

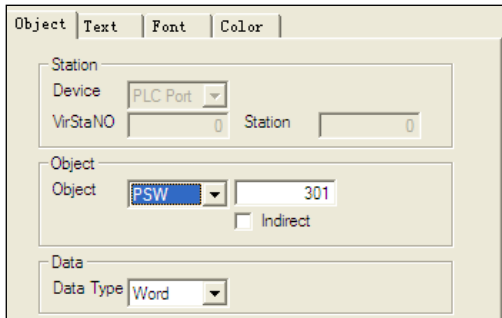

- Select the object with register PSW301, which means when the value of PSW301 display when PSB307 is triggered.

5.3.2 'Event button' editing

Click component  from toolbar and set property as below:

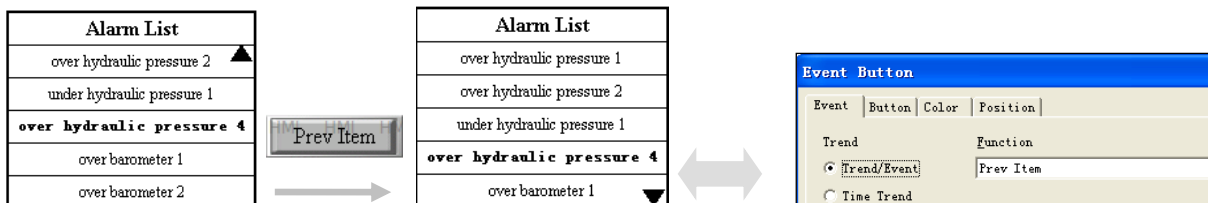

Other components are similar to this ,more details please refer to above .

5.3.3 'Digital input' editing

Click component  from toolbar and set property as below:

PSW300



Property setting



Alarm message is triggered by PSB306

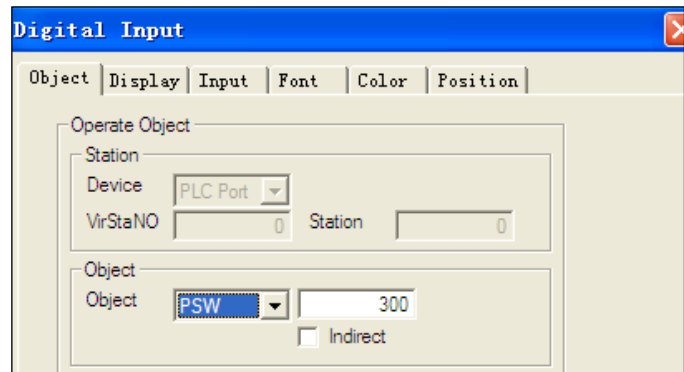

PSW301



Property setting



Alarm message is triggered by PSB307

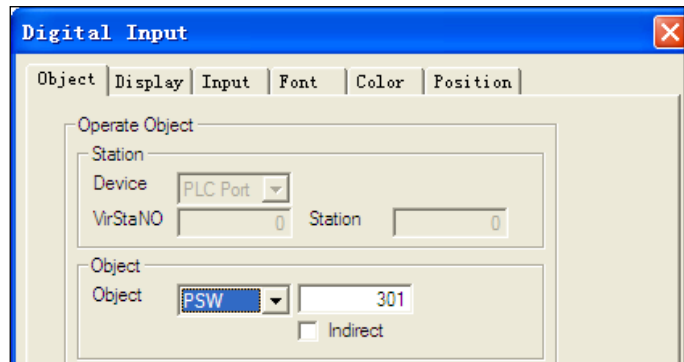

5.3.4 'Lamp button' editing

Click component  from toolbar and set property as below:



- 7 lamp buttons whose range is from PSB300 to PSB306.

Thus, the whole project is finished.

5.4 Notes

The selection on alarm message can be achieved by 'event button' when amount of alarm messages is more than the number set.

6 Net function

6.1 Introduction

Both TH series panels and TP series panels support Net functions which means one objective device can be controlled by several panles,specially in the situations where monitoring is need.

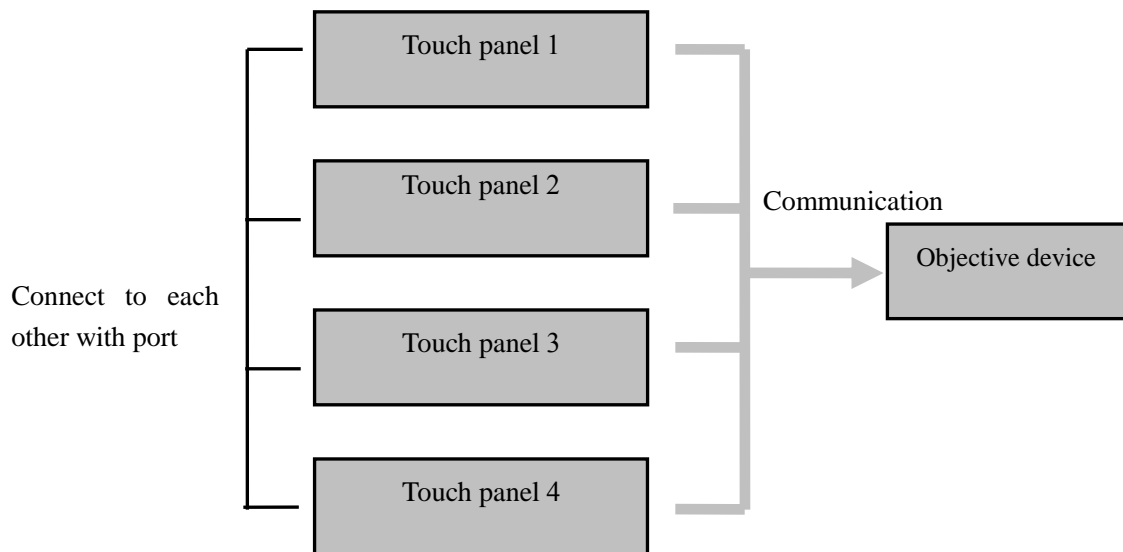

The panels is comprised of host net panel and slave net panels. Only one panel controls as a host ,other panels are in slave mode which connects to each other via RS485 with independent station NO.

The structure is showed as below

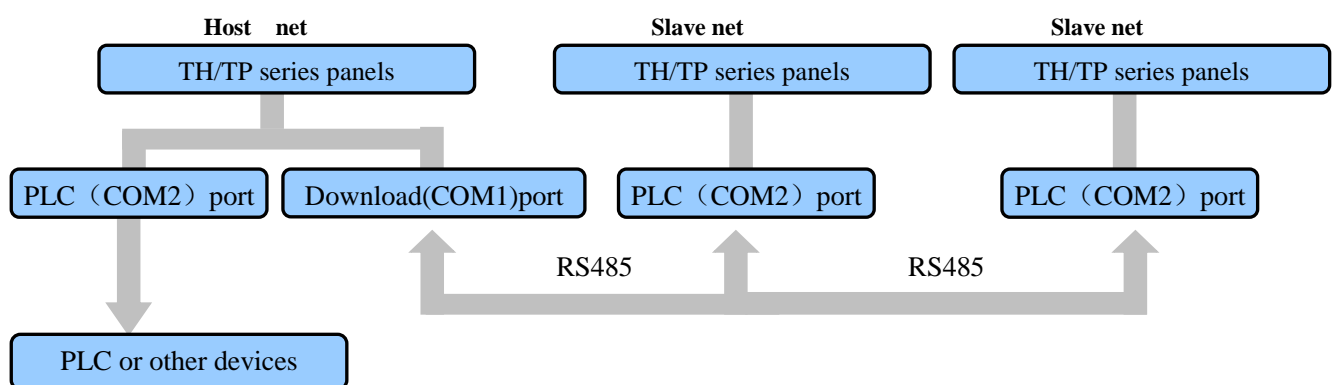

For example,the structure of system comprised of four panels and one PLC is showed as below:

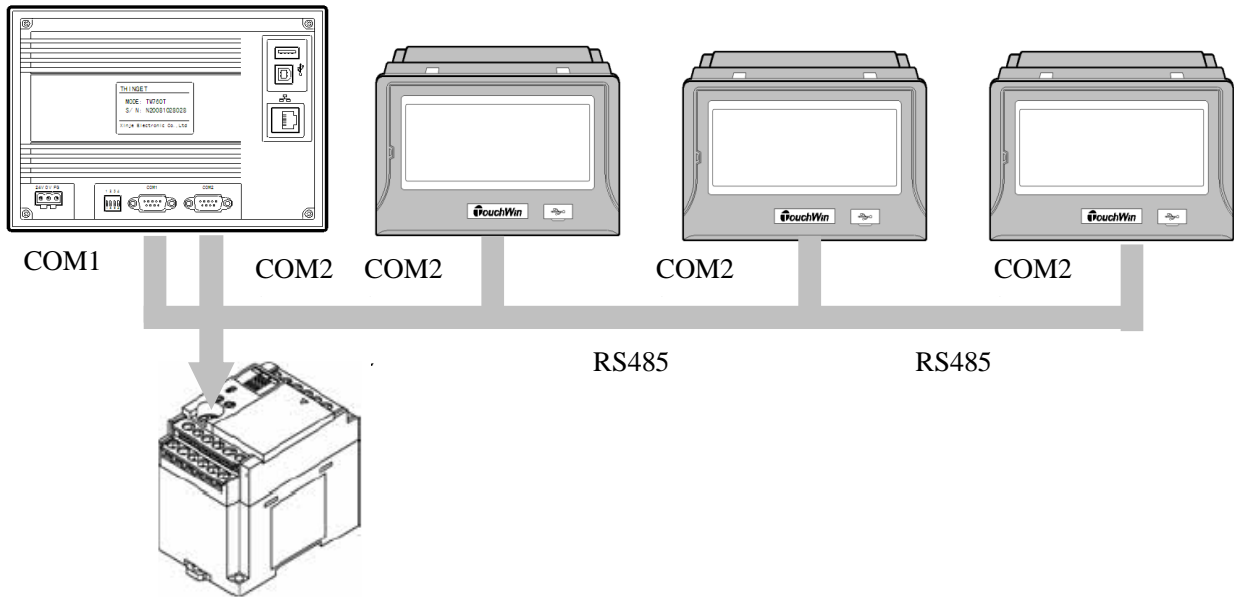

6.2 Procedure

The following chapters will take the sample to show how to set this net system including three panels and one PLC.

Connection is shown as below.

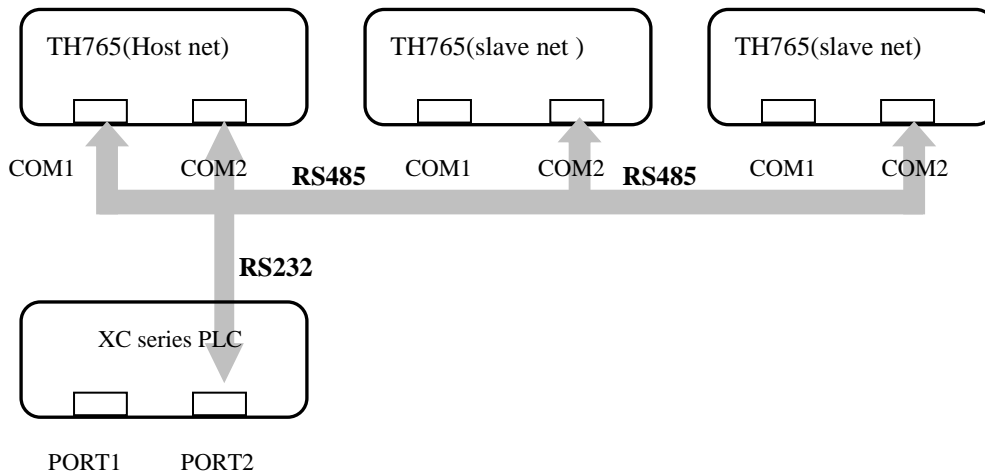

All devices comprised this system is showed as below:

Name	Type	Description	Action
TH series panel	TH765-M	Host net	Control the output Y0
TH series panel (station NO.1)	TH765-M	Slave net	Set Y1 at 2-seconds intervals

TH series panel (station NO.2)	TH765-M	Slave net	Set Y2 by button then turn off automatically after 3 seconds
XC series PLC	XC3-24R-E	As control object	

Procedure

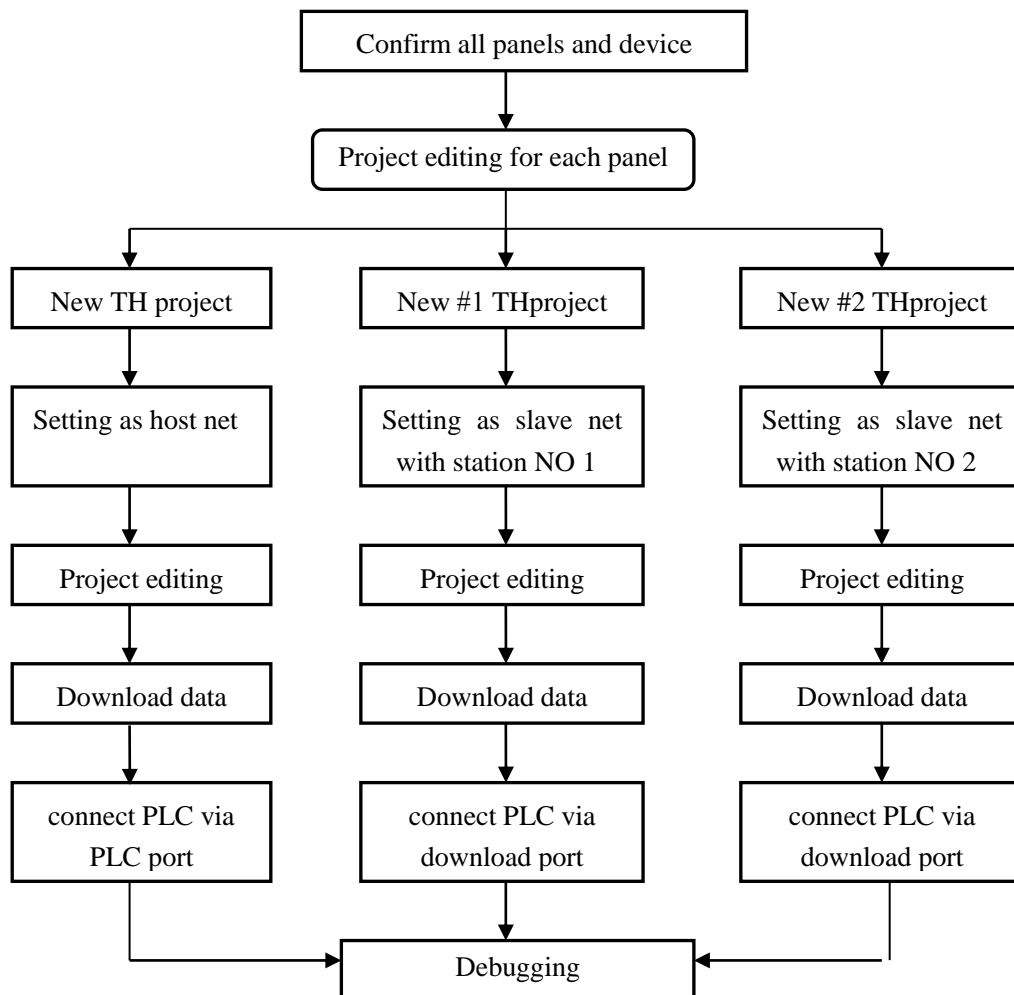

6.2.1 Project editing on panel(host net)

- Mode setting :

Set as path 'file/system setting/device',as below:

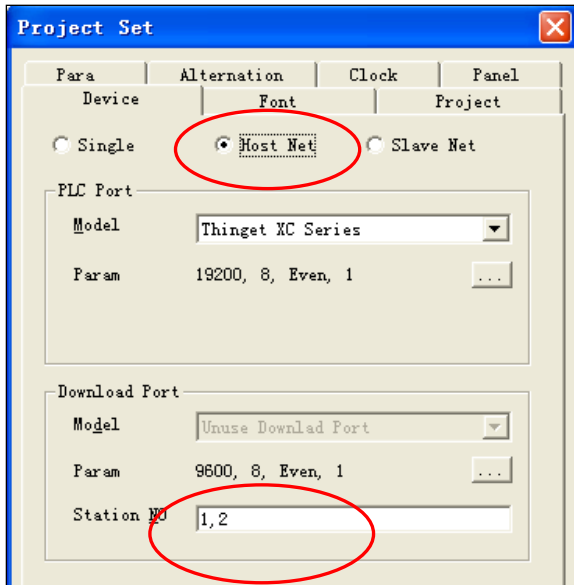

- Set as 'host net'.

- Connect salve panel via download port ,enter station NO 1 & 2 ,as left.

- Project editing

Do the inverse operations to PLC output via lamp button.

Click component  from toolbar and set property as below:

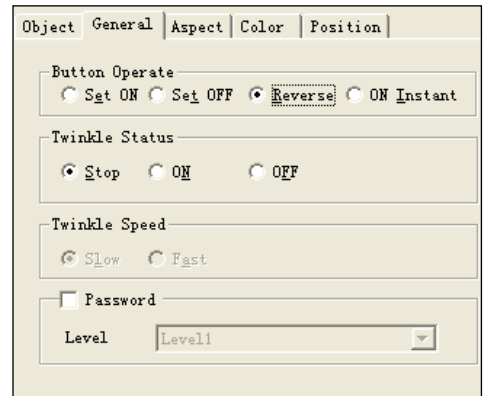
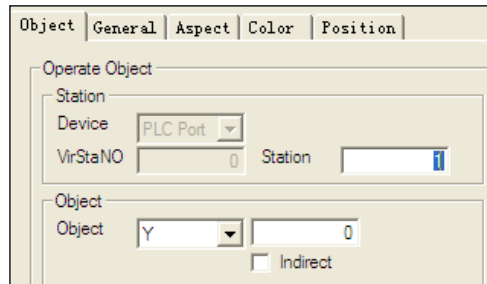
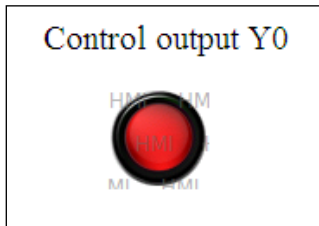

- Property of 'object': with Y0;
- Property of 'general': set as 'inverse';

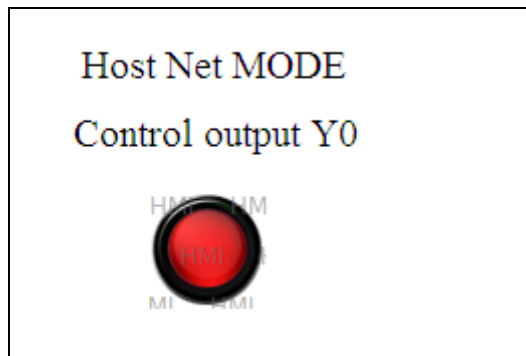

6.2.2 Project editing on panel(salve net 1#)

This chapter describe how to set the output Y1 at 2-second intervals.

Mode setting:

Set as path ‘file/system setting/device’ as below

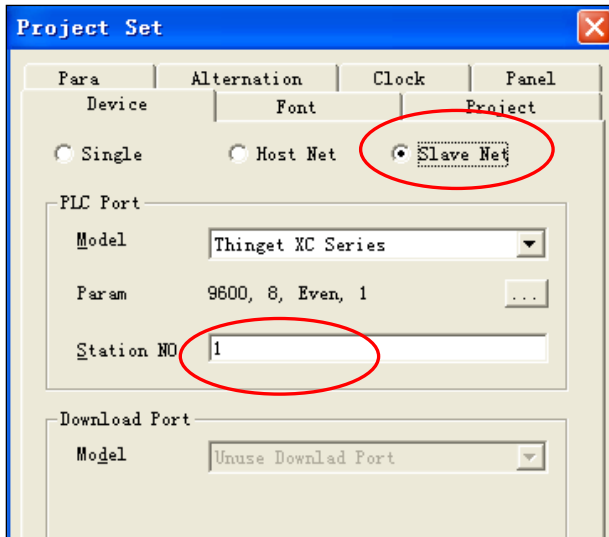

- Set as ‘slave net’.
- Set the station NO as 1

Project editing

In this screen,output Y1 is controled by PSB300 at 2-seconds intervals.

(1) Component PSB300

Click component  from toolbar,and set property as below:

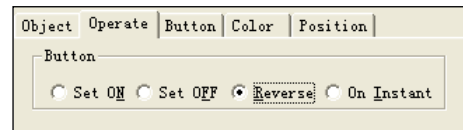
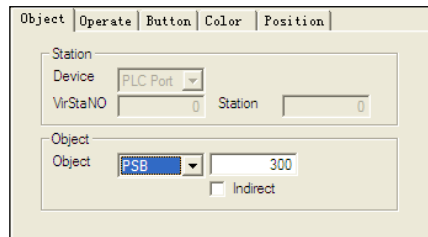

- Property of ‘object ’, with PSB300;
- Property of ‘general’;set as ‘inverse’

(2) Componnet ‘function field’

Click component  from toolbar and set property as below

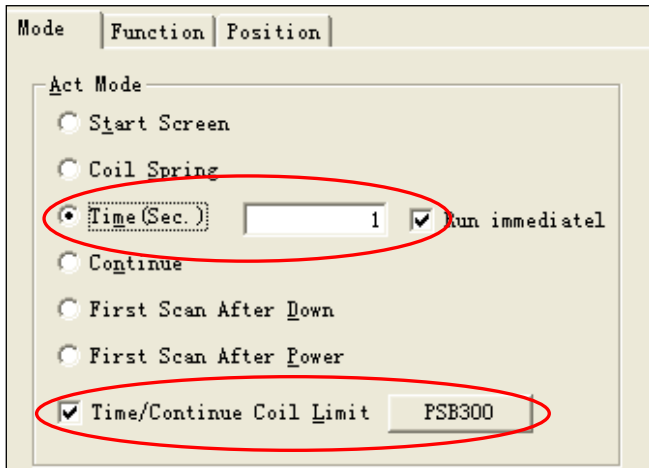

Control Y1 by PSB300

- Select 'time': set Y1 and keep 1 second and another second keep as off status
- 'Time' is available when triggered coil PSB300 is on

Property of 'function'

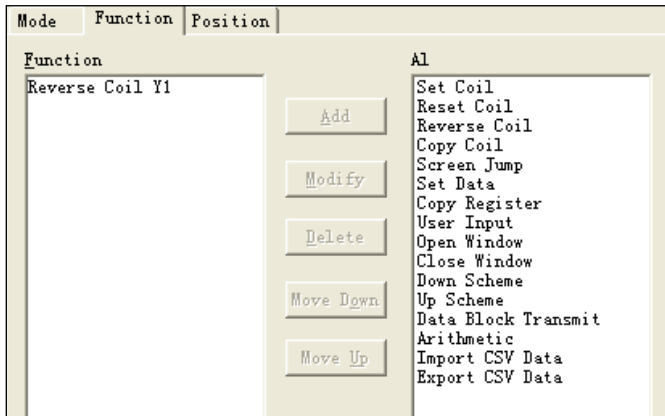

- Select 'reverse coil' function with object Y1

Thus, the project of salve-net 1# is showed as below:

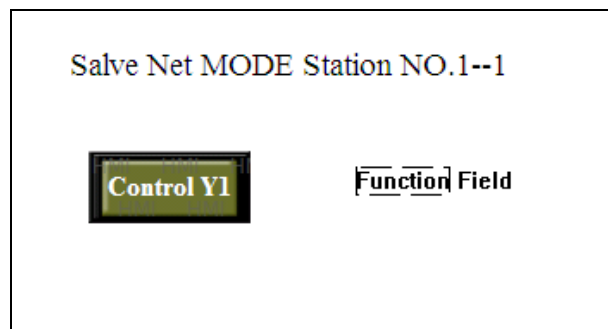

6.2.3 Project editing on panel(salve net 2#)

This chapter describe how to set the output Y2 to achive objective operation

Mode setting:

Set as path 'file/system setting/device' as below

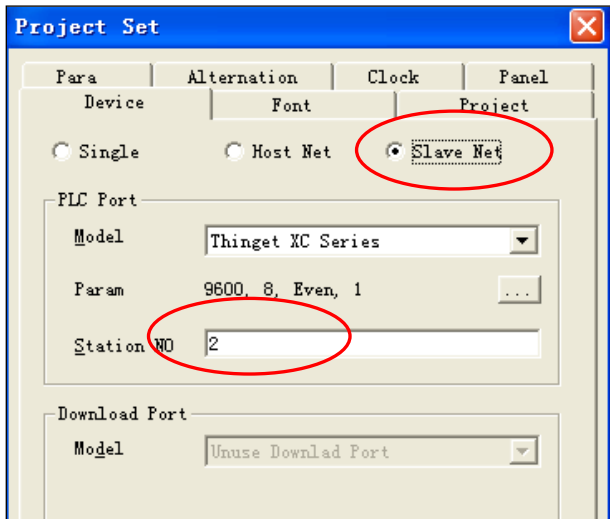

- Set as 'slave net'
- Set the station NO as 2

Project editing

In this screen, output Y2 is set via button and turns off automatically after 3-seconds.

(1) Component 'button'

Click component  from toolbar, and set property as below:

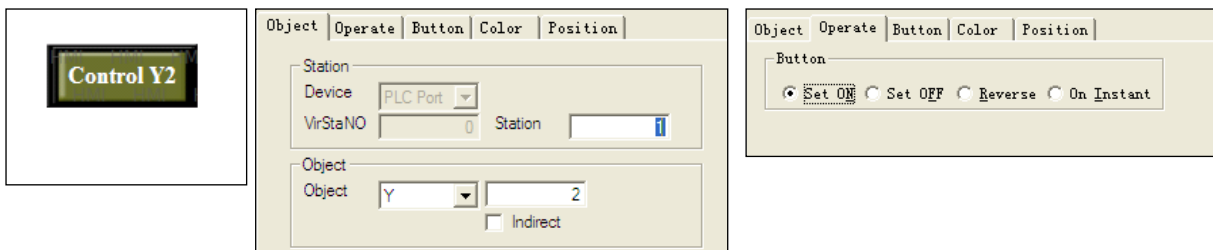

(2) Component 'function field'

Click component  from toolbar and set property as below

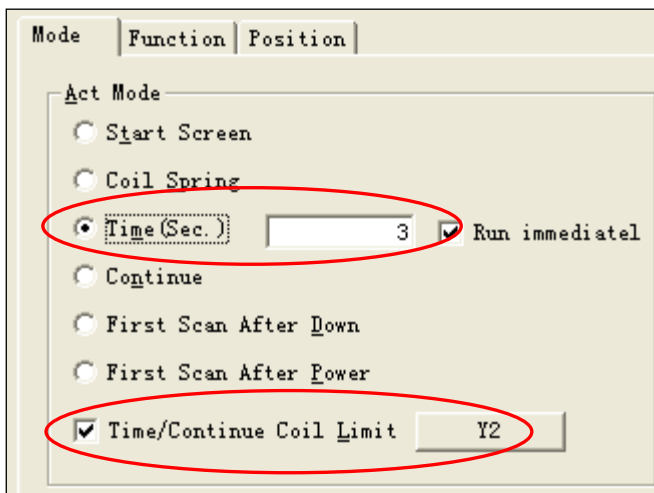

The time start to count when Y2 is turn on via button, set the constant time with 3 seconds.

Property of 'function'

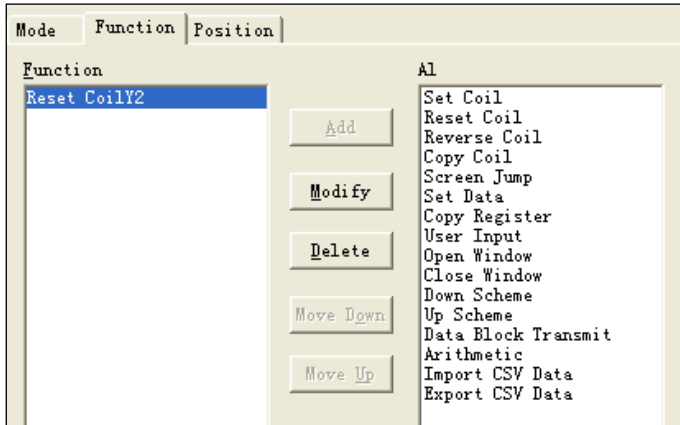

- Select 'reset coil'function with object Y2

Thus, the project of salve-net 2# is showed as below:

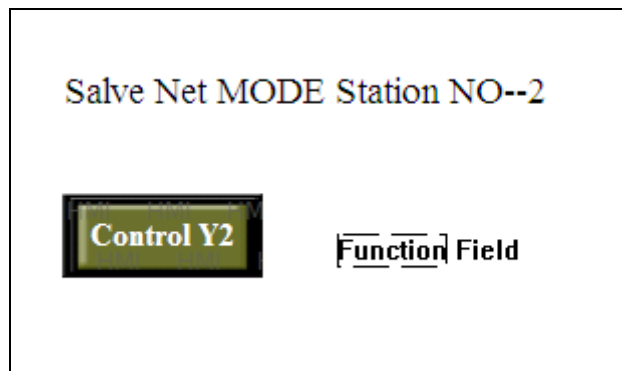

Above all, the whole project is showed as below:

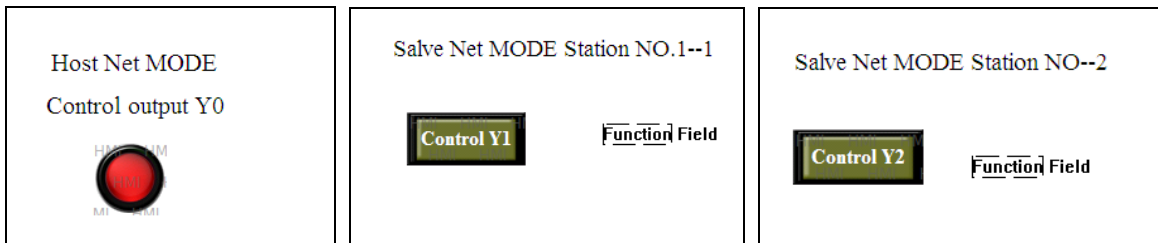

6.3 Note

During the above example ,we used all TH series panels as the control devcie with COM1 port in communication mode directly,while use TP series panels ,please convert COM1port from download mode to communication mode first ,otherwise ,the commuication will be lost.

7 Data grid & Grid control

7.1 Introduction

Both 'Data grid' and 'Grid control' can display continuous register values in list form, the register address is shown as diagram 1

This list starts from PSW300 to PSW309:

PSW300	PSW301	PSW302	PSW303	PSW304
PSW305	PSW306	PSW307	PSW308	PSW309

Diagram 1

Address assignment rule: from left to right, from up to down.

The difference between these two components is:

1. 'Grid control' is usually used to modify data where needs large numbers to monitor.
2. 'Data grid' displays data with circle buffer and time.

This difference is shown in the 'Column' form, the details will be described in following chapters.

7.2 Description

Examples:

Matched with component 'sample save', this example collects data from registers PSW300 and PSW301 to be saved in registers with first address PSW300. All sample data is divided into 10 groups and displays values via 'data grid' and 'grid control'.



Description regarding the other component used in this example please refer to <HMI manual basic>, or get from website <http://www.xinje.com>.

Click component 'sample save'  from toolbar and set property as below:

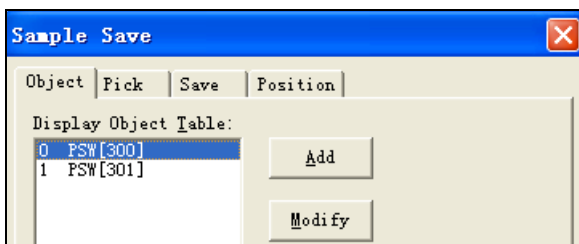

Diagram 2

- Object : set object with PSW300 and PSW301, as left.

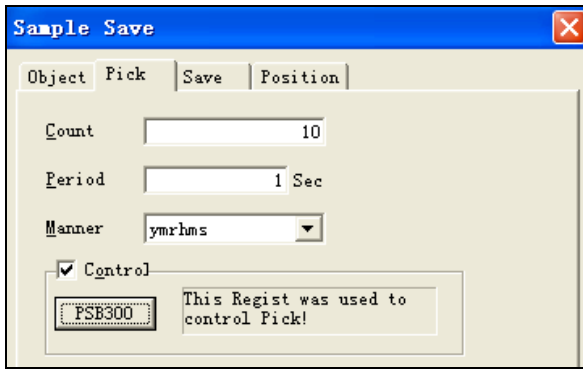

Diagram 3

- Pick
- Count: 10
- Period: 1 second.
- Manner: y/m/r/h/m/s
- Control: select and with object PSB300(this regist was used to control pick action)

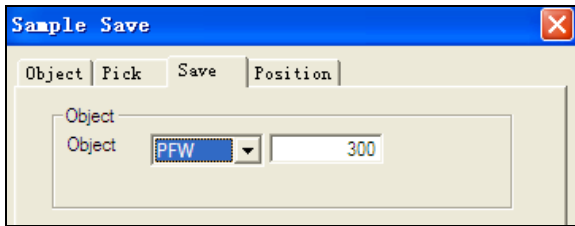



Diagram 4

- Save object: PFW300 (First address)

Click one component 'lamp button'  and two components 'digital input'  then set property as below:

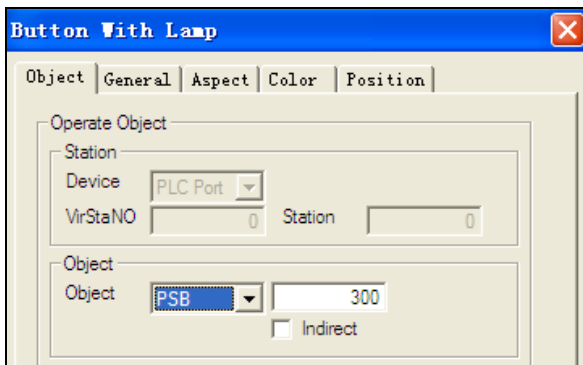

Diagram 5

- Property of object : PSB300.



Diagram 6

- Button operate : Reverse . (convert between ON and OFF once press)

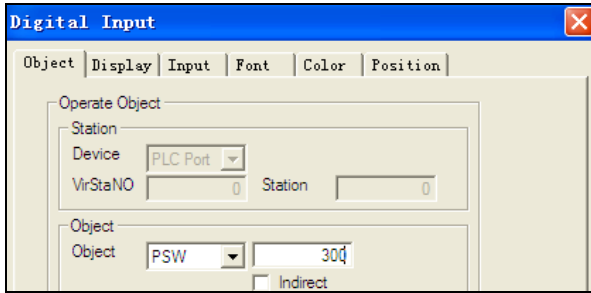

Diagram 7

- Object : set PSW300 and PSW 301 respectively.

Click component 'grid control'  and set property as below:

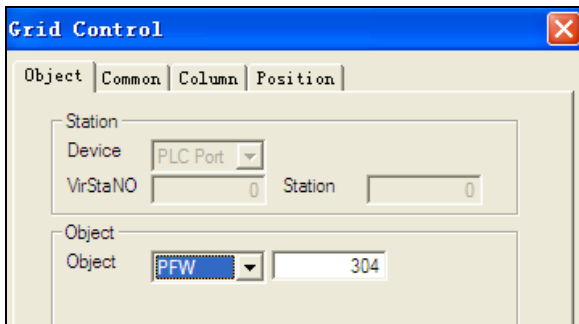

Diagram 8

- Object : set first address with PFW304 (With 'circle buffer'takes up 4 registers from PFW300 to PFW303,so take PFW304 as start)



More details regarding 'circle buffer'please refer to introduction of 'sample save'parts

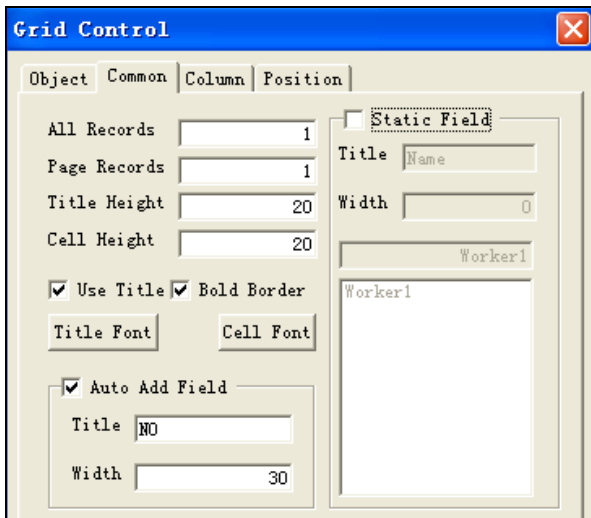

Diagram 9

- All records: amount of all record of this list.
- Page record: records showed on each page.
- Title height: height of title
- Cell height: height of each
- Use title: use title or not
- Bold font: bold or not
- Font: select font that you want.
- Auto add field: as record NO.
- Static field: set title name of each line

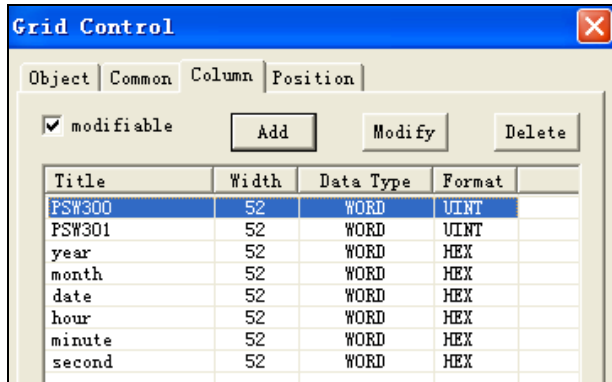

Diagram 10

- Modifiable: data can be modified when selected
- Add/modify/delete: add new column by press **Add** and modify by press **Modify**

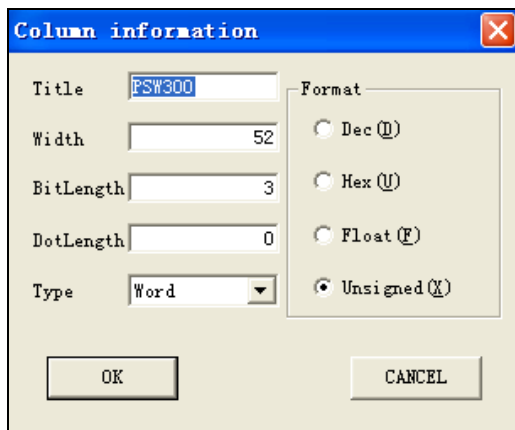

Diagram 11

- Title: title of column
- Width : width of column
- Bitlength/dolength: set length of data,(set dolength as 4 when display year information)
- Type : data type

Description of type: Byte , Word, Dword, String.

- Format: format of data
DEC ,HEX,FLOAT,UNSIGNED
Time is in HEX format

Click component 'data grid'  from toolbar and set property as below:

There only show the difference between these two components :

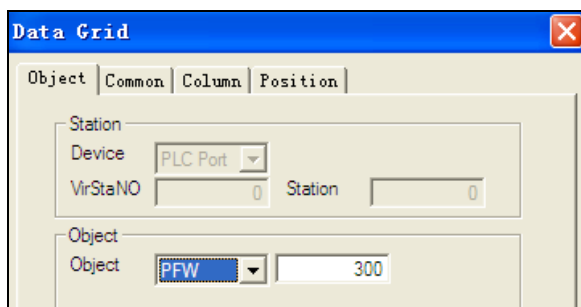

Diagram 12

- Object : PFW300. (first address from PFW300, it is important to noted this is difference from 'grid control')

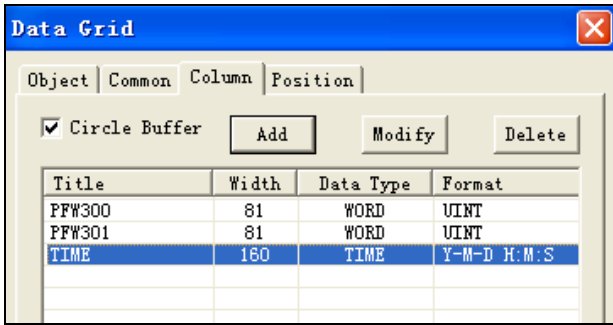

Diagram 13

- Circle buffer: when selected the saved register from the register that 'object' set. Is showed as left.



More details regarding 'circle buffer' please refer to introduction of 'sample save' parts

- Add/modify/delete: add new column by press and modify by press , as showed diagram 13



Diagram 14

- Time : when selected the data will display as form Y-M-D H:M:S.

Investigate the data in the two list via emulator offline.

7.3 Description on setting

Property of 'object' for lamp button

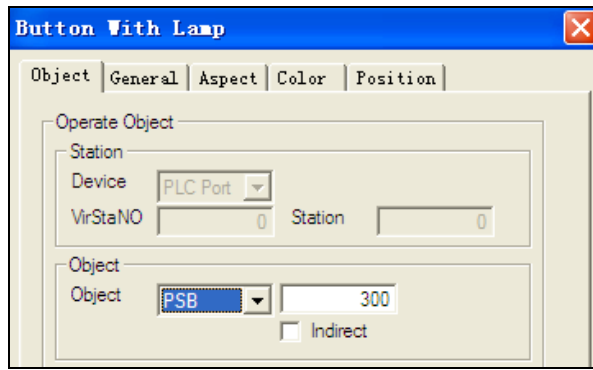

Diagram 15

Setting	Description
Object	As operation object

Property of 'common' for grid control

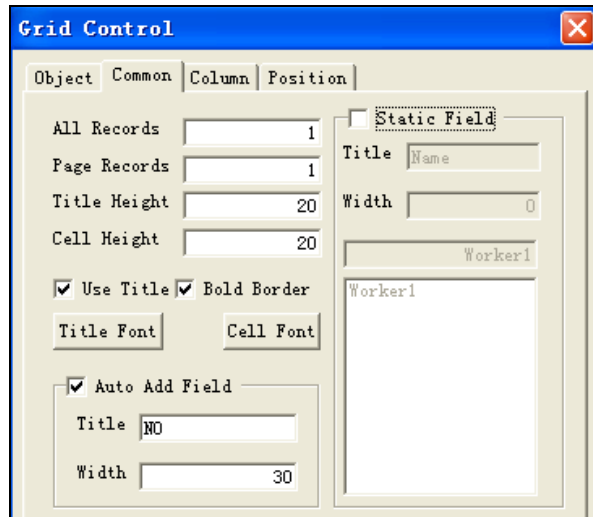
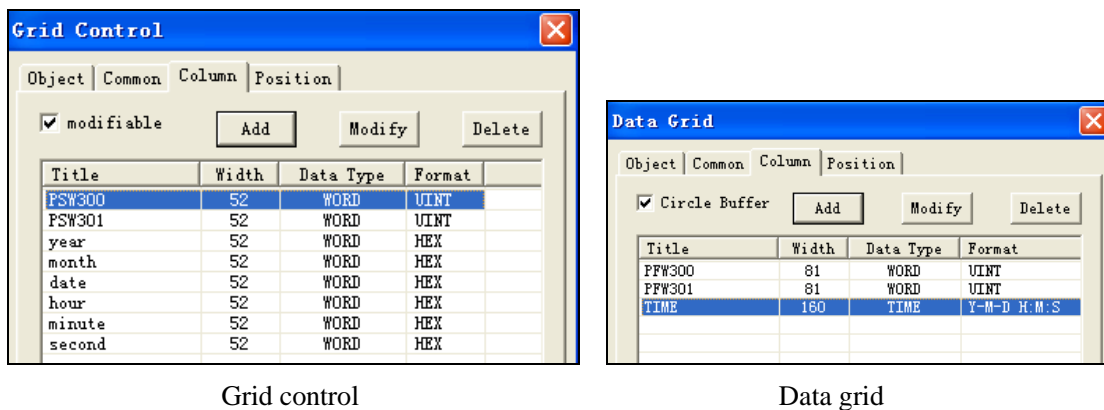

Diagram 16

Setting	Description
All record	amount of all record of this list
Page record	records showed on each page.
Title height	height of title
Cell height	height of each
Use title	use title or not
Bold border	bold or not
Title/cell font	set font that user want
Auto add field	as record NO.increased from up to down
Static field	set title name of each line

Prop

erty of 'Column'



Grid control

Data grid

Diagram 17

Setting	Description
Add/modify/delete	Add new column and modify
Modifiable(grid control)	Data can be modified when selected
Circle buffer	When this item is selected, the first 4 registers is taken as 'circle buffer'

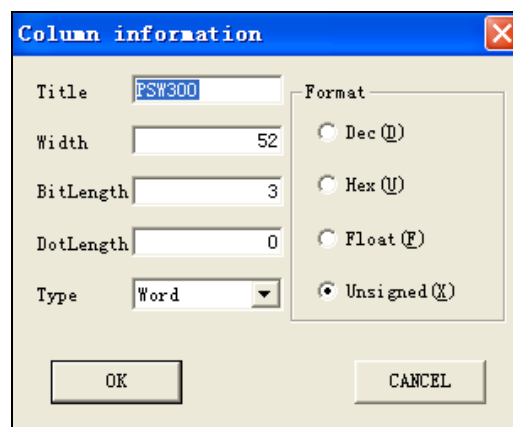

Diagram 18

Property of 'column'

Setting	Description
Title	title of column

Width	width of column
Bitlength/dolength	set length of data,(set dolength as 4 when display year inforamtion)
Type	data type
Fornat	format of data. DEC ,HEX,FLOAT,UNSIGNED

8 XY curve

Introduction

This component is used to display object position on plane coordinate with fold or dot mode. Datas collecting from 2 registers can be compared with the referenced curve ,bringing convenience for investigation and debugging.

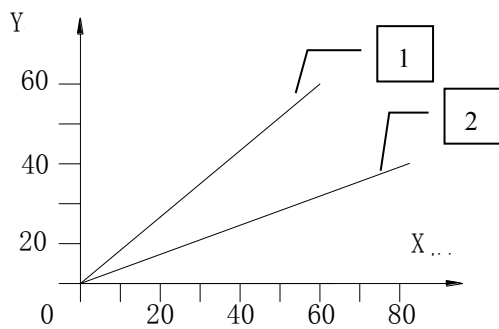

Diagram 1

NO.1: Destination curve with fold mode

NO.2: Sample curve with fold mode

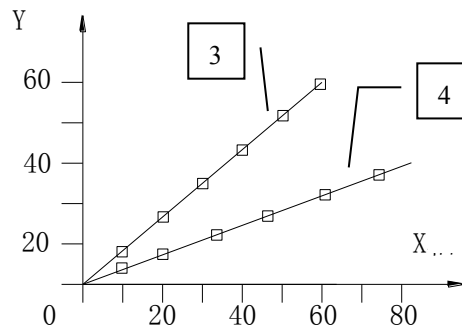

Diagram 2

NO.3: Destination curve with dot mode

NO.4: Sample curve with dot mode

Description

Example :

Take registers PSW300 and PSW301 as data source ,and compare sample cure with destination curve.



Other components included in this example please refer to the 'Basic manual for touch panels'.get from website“<http://www.xinje.com>”

Procedure

Cilick component 'XY curve'  from toolbar and se property as below:

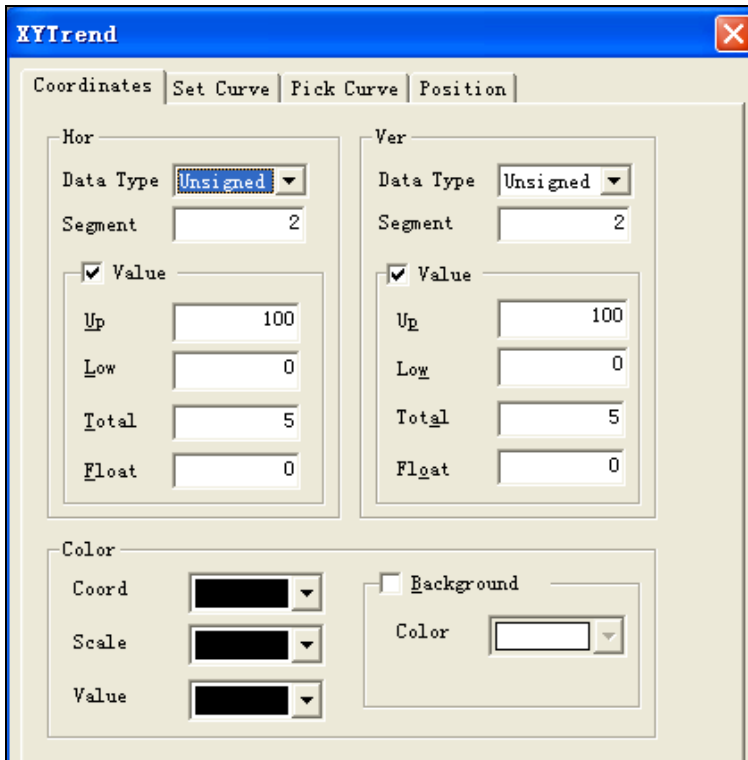

Diagram 3

- Horizon:
 - Data type: select data type of horizon, the same as the data source.
 - Segment: set the numbers of scales segments.
 - Value: display the value of the scales when selected.
 - Up/Low value: set upper-limit value and lower-limit value.
 - Total: the bitlength of scales.
 - Float: the dolength of scales.
- Vertical: parameters setting refer to 'horizon' setting.
- Color: set color for curve.

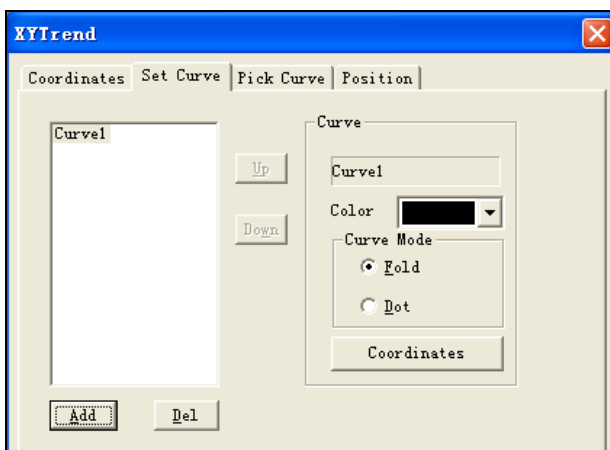
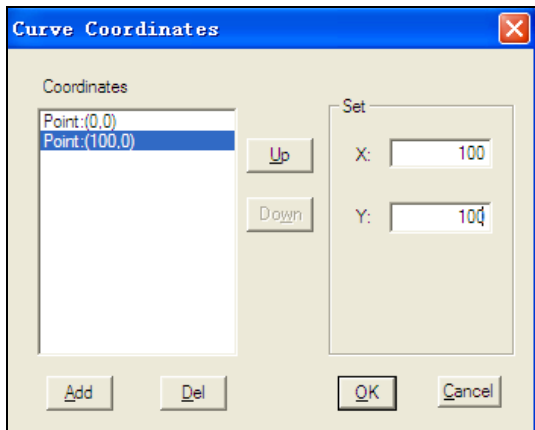

Diagram 4

- Add/Del: add or delete a set curve as referenced curve for pick curve.
- Curve :
 - Color : select destination color.
 - Curve mode: with fold mode or dot mode.
 - Coordinates: set coordinates value, double-click to set details.



- Add/Del :add/delete coordinates and set value via right box.

Diagram 5

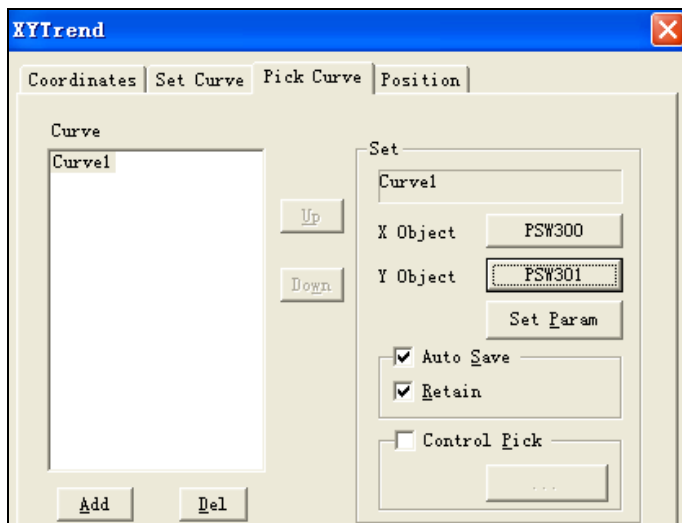

Diagram 6

- Add/del : add/delete a pick curve.
- Set
 - X Object/Y Object: set data source for sample.(In this example,X axis collect from PSW300,Y axis is from PSW301).
 - Set parameters: parameters setting for curve(double-click to enter into this mode,refer to diagram 7)
- Auto Save: coordinates value is saved into internal space automatically when this item is selected. Otherwise ,the values saved from the address defined by user.
- Retain :collecct data saved in retentive registers ,keeps value for ever,otherwise,data lose when power off.
- Control pick: object coil used to control pick. If selected that means the data collection start with coil is ON.

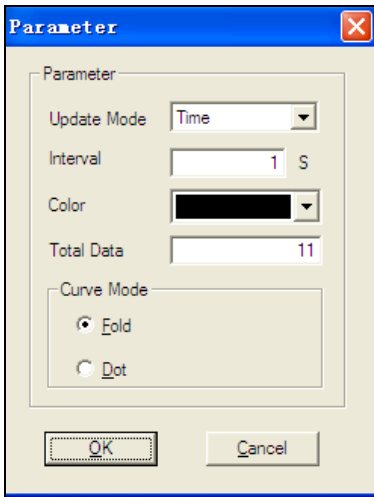

Diagram 7

- Update Mode:select mode that you want .
 - I. Time : updat curve at intervals (interval unit is second)
 - II. X value changed: new curve is generated once value of X axis is changed.
 - III. Y value changed: new curve is generated once value of Y axis is changed.
 - IV. X or Y value changed: new curve is generated once either X or Y axis value is changed.

- Color: set color of pick curve.
- Total data: number of data can be display.The earliest data will be replaced when there is more datas.
- Curve mode: set mode with fold or dot.

click two components ‘digital input ’ from toolbar and set property as below:

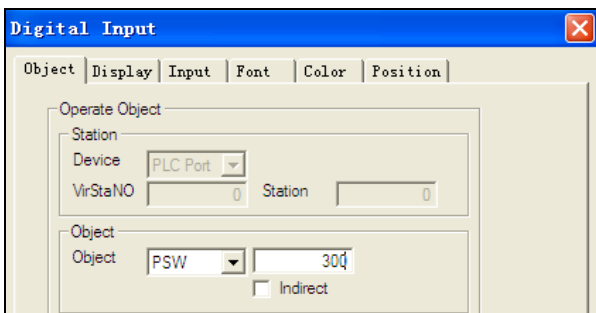

Diagram 8

- Object : set with PSW300,and the other with PSW301.

Thus,all setting is finished and investigate the curve by emulator offline.

Input data via component ‘digital input’.

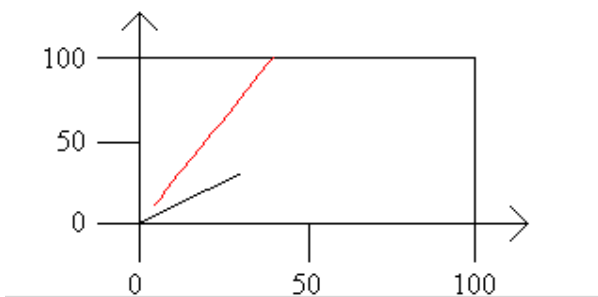
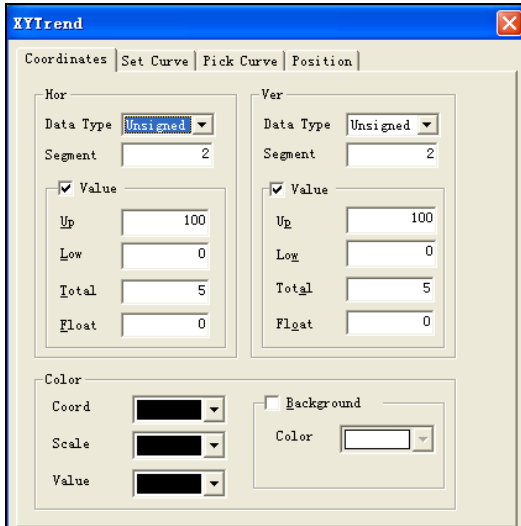

Diagram 9

- Black curve: stand for set curve(destination curve).
- Red curve:stand for pick curve(actual curve)

Description for parameter setting:

Property of ‘coordinates’



Parameter	Description
Data type	select data type of horizon, the same as the data source.
Segment	set the numbers of scales segments
Up/Low value	set upper-limit value and lower-limit value.
Total/ Float	the bitlength of scales the dolength of scales
Color	set color for curve.

Property of set curve

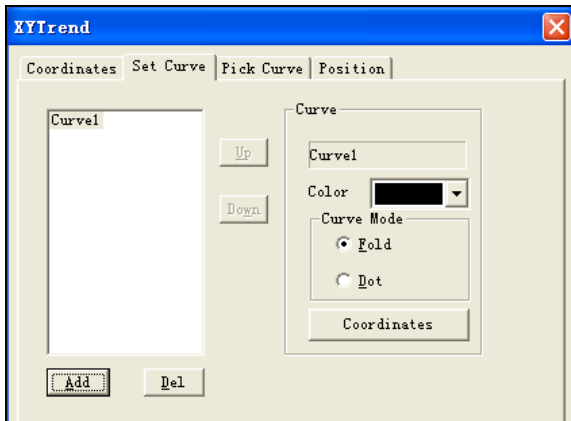

Parameter	Description
Add/Del	add or delete a set curve as referenced curve for pick curve
Color	selevt destination color.
Curve mode:	with fold mode or dot mode.
Coordinates	set coordinates value

Property of 'pick curve'

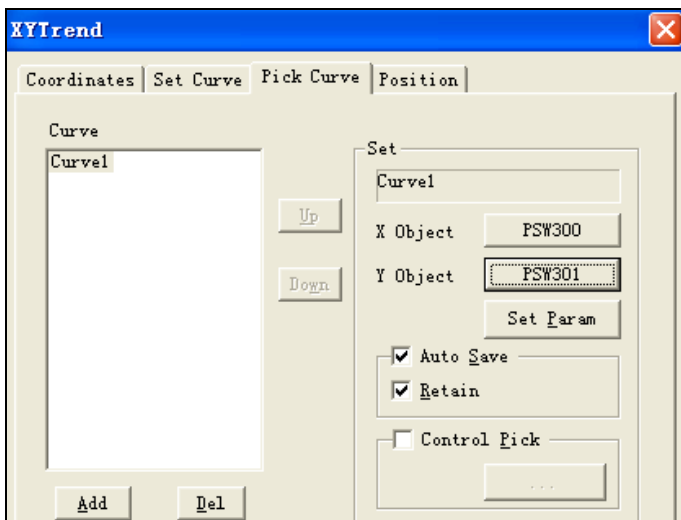

Parameter	Description
Add/del	add/delete a pick curve.
Set	X Object/Y Object: set data source for sample.(In this example,X axis collect from PSW300,Y axis is from PSW301). Set parameters: parameters setting for curve(double-click to enter into this mode,refer to diagram 7)
Auto Save	coordinates value is saved into internal space automatically when this item is selected. Otherwise ,the values saved from the address defined by user.
Retain	collecct data saved in retentive registers ,keeps value for ever,otherwise,data lose when power off.
Control pick	object coil used to control pick. If selected that means the data collection start with coil is ON.

Property of 'set parameters'

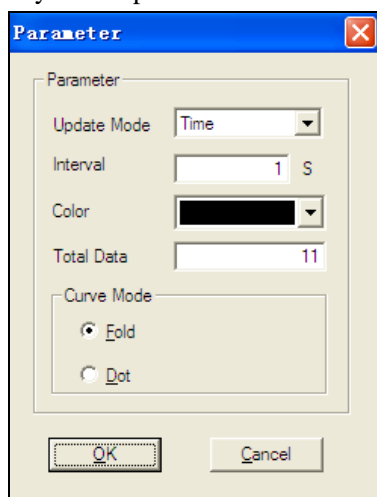

Parameter	Description
Update Mode:	I. Time : updat curve at intervals (interval unit is second) II. X value changed: new curve is generated once value of X axis is changed. III. Y value changed: new curve is generated once value of Y axis is changed. IV. X or Y value changed: new curve is generated once either X or Y axis value is changed. V.
Color	set color of pick curve.
Total data	number of data can be display.The earliest data will be replaced when there is more datas.
Curve mode:	set mode with fold or dot.

9 Sample save

Introduction

This component supports both data collection and data save for ation datas .

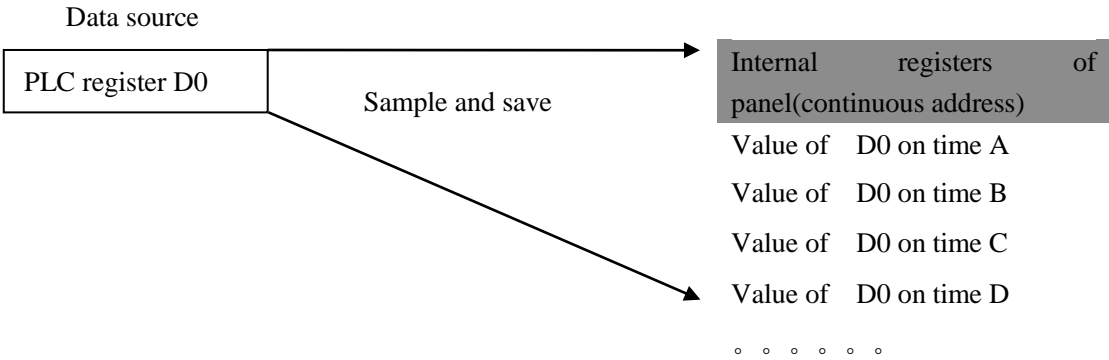

Diagram 1

Description

Example :

Collecting 20 groups datas from data sources PSW300 and PSW301 then save to the registers with beginning PFW300.



Other components included in this example please refer to the ‘Basic manual for touch panels’.get from website“<http://www.xinje.com>”

Click component ‘sample save’ and set property as below:

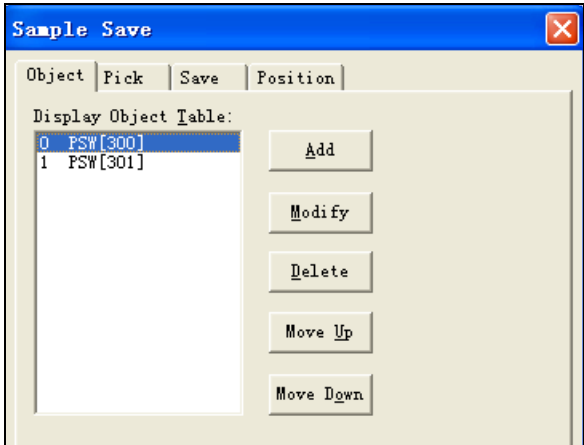

Diagram 2

- Add:add a new data source;
- Modify: modify the data source;
- Delete : delete the chosen data source;
- Move up/move down:move the chosen data source up or down.

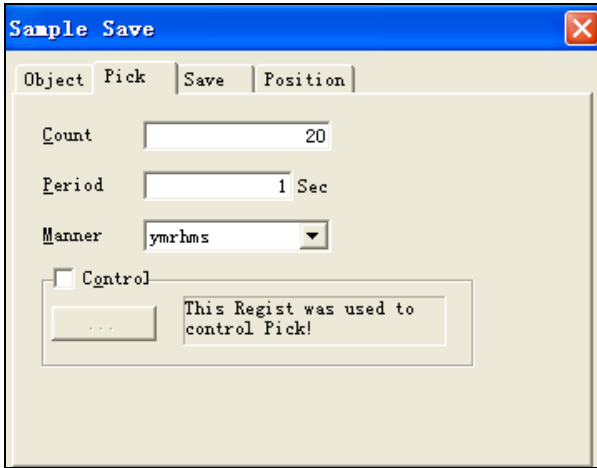

Diagram 3

- Count: pick times
- Period: interval between two picks
- Manner: time manner
- Control: this regist was used to control pick.(sample all the time if not selected)

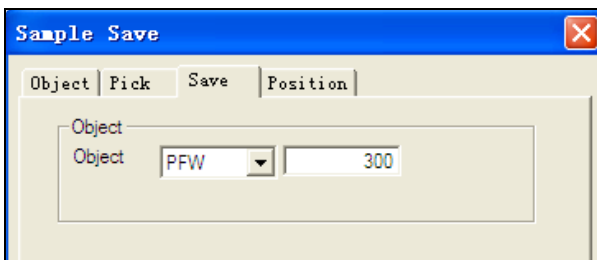

Diagram 4

- Object :define the beginning register for data saving(in this example ,data is saved from register PFW300.)

Click component 'grid control'  from toolbar and set property as below:

This component used in this sample is for data investigation, but please note this componnet is not necessary to be macthed with component 'sample save'.

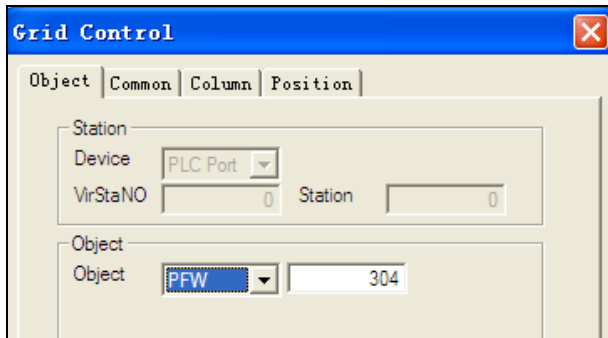

Diagram 5

- Object: display datas from register PFW304.
- Note : 'sample save' takes up 4 registers as 'circle buffer' where address pointer lies. These pointers indicate address for data saving, structure is shoewd as below(diagram 6)

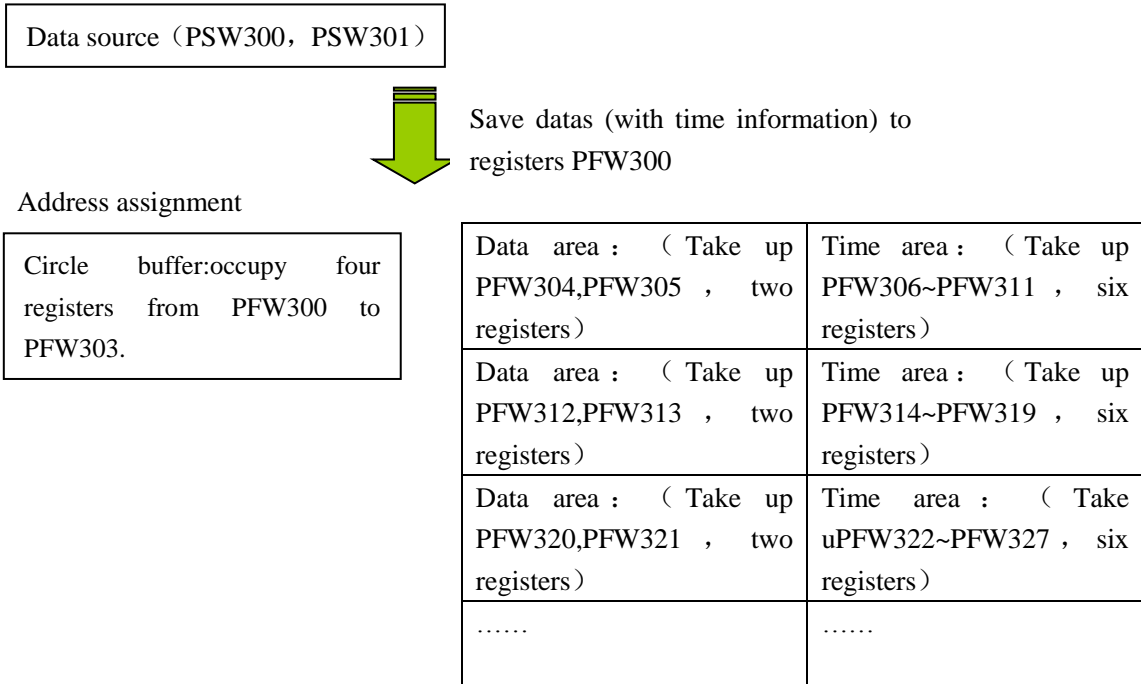

Diagram 6

As said above,'grid control'display datas from PFW304 because there is no need to know the values of circle buffer.

Data area displaying time information is assigned in sequence: year ,month,date,hour,minute,second(in HEX format).

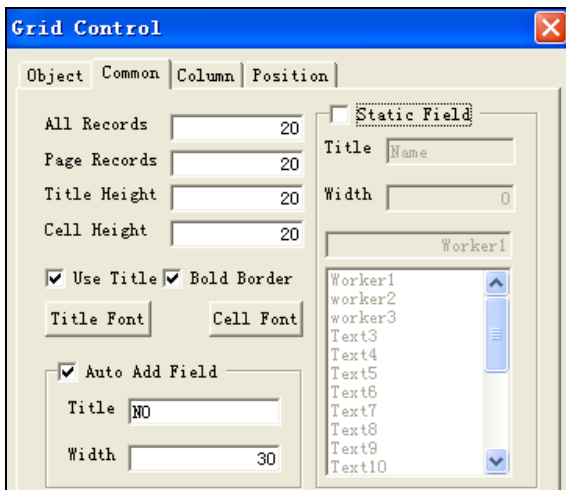

Diagram 7

- All records:20(20groups to be sampled)
- Page records:set same as 'all record'(page record can not more than all records)
- Static field:not selected in this example.

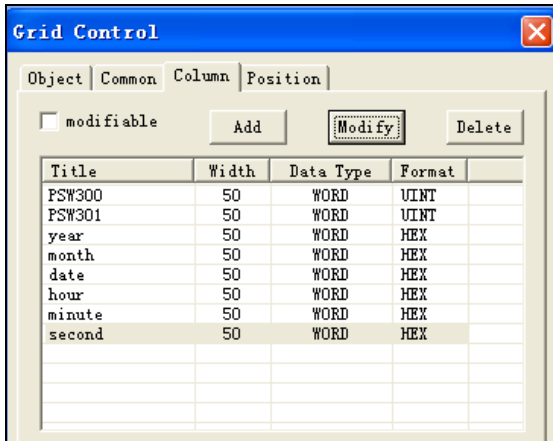

Diagram 8

- Add/modify/delete:add to 8 columns(as showed diagram 8)

- Note: year information display in 4 bits .

Click 2 components 'digital input ²³' from toolbar and set property as below:

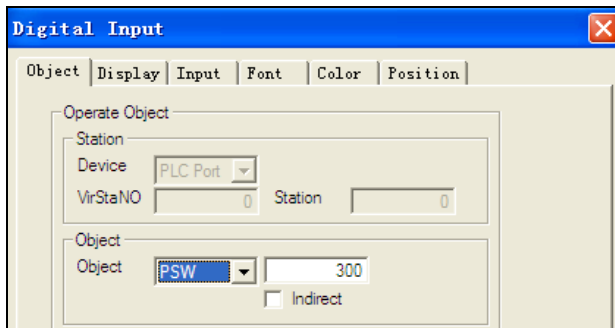



Diagram 9

- Object : one set with PSW300.the other set with PSW301.

After all components setting over,investigate run status via emulator offline.





NO	PSW300	PSW301	year	month	date	hour	minute	second
0	500	200	2009	10	23	13	11	17
1	500	200	2009	10	23	13	11	18
2	500	200	2009	10	23	13	11	19
3	500	200	2009	10	23	13	11	22
4	500	200	2009	10	23	13	11	23
5	500	200	2009	10	23	13	11	24
6	500	200	2009	10	23	13	11	25
7	500	200	2009	10	23	13	11	26
8	500	200	2009	10	23	13	11	27
9	500	200	2009	10	23	13	11	28
10	500	200	2009	10	23	13	11	29
11	500	200	2009	10	23	13	11	30
12	500	200	2009	10	23	13	11	31
13	500	200	2009	10	23	13	11	32
14	500	200	2009	10	23	13	11	33
15	500	200	2009	10	23	13	11	34
16	500	200	2009	10	23	13	11	35
17	500	200	2009	10	23	13	11	36
18	500	200	2009	10	23	13	11	37
19	500	200	2009	10	23	13	11	15

Diagram 10

Description of parameters setting

“Property of ‘object’

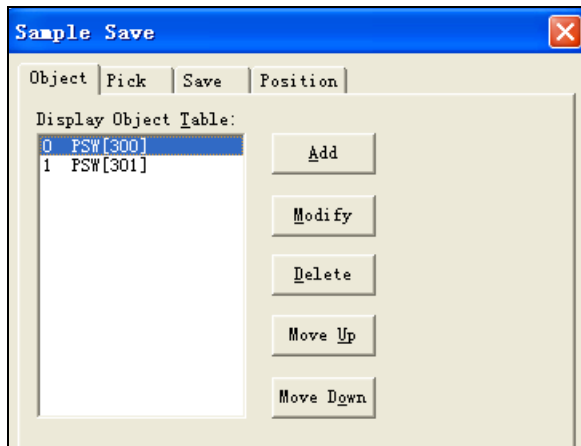

Parameter	Description
Add/Modify /Delete	add /modify the data source/delete data source;
Move up/move down	move the chosen data source up or down.(this operation effect the sequence of data saving)

“Property of ‘Pick’



Parameter	Description
Count	pick times
Period	interval between two picks
Manner	time manner
Control	this regist was used to control pick.(sample all the time if not selected)

“Property of ‘save’

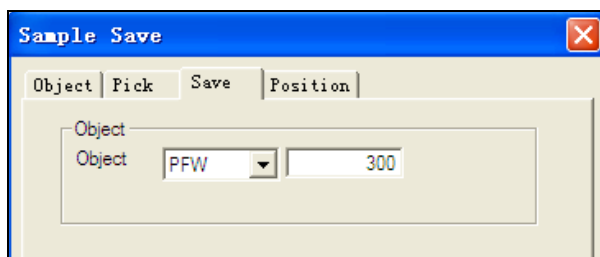

Parameter	Description
Object	define the beginning register for data saving(in this example ,data is saved from register PFW300.)

10 XY Curve Ex

10.1 Introduction

XY curve EX is used to display a series values from X axis and Y axis with fold mode. The difference compared with XY curve is:

First ,XY curve Ex display datas from continuous registers rather than two fixed registers(X is from one register,and Y is from one register).

Second: There is no referenced curve for comparing.

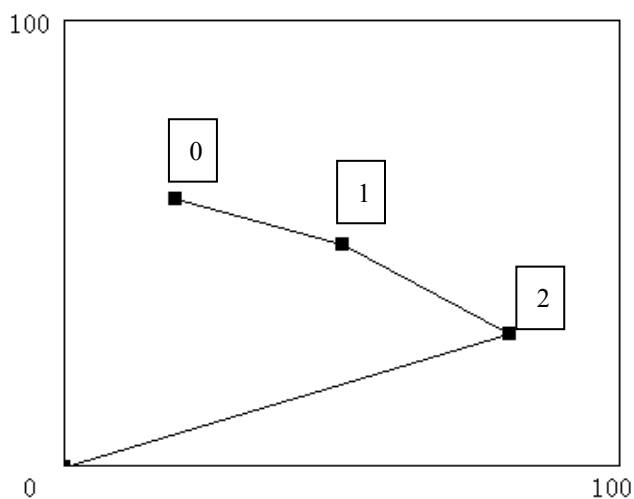

NO.	X value	Y value
0	20	60
1	50	50
2	80	30

Diagram 1

10.2 Description

Example :

Draw XY curve based on values from 20 registers from PSW300 to PSW319 with 10 dots.



Other components included in this example please refer to the 'Basic manual for touch panels'.get from website"<http://www.xinje.com>

Click pomonent 'XY curve Ex'  from toolbar and set property as below:

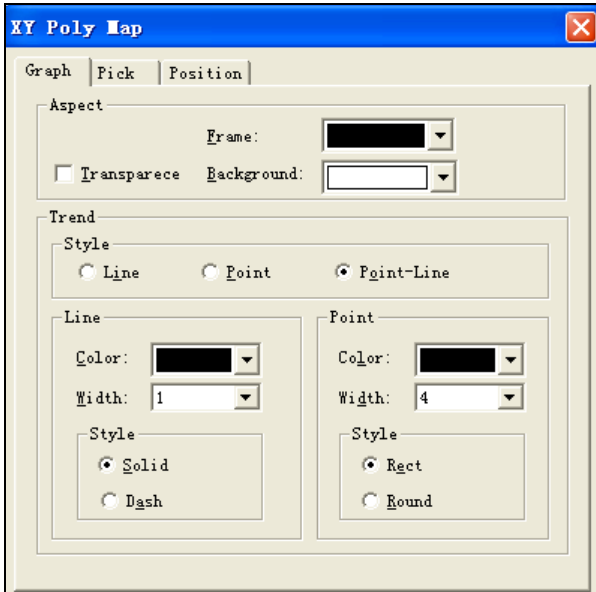

Diagram 2

- Aspect: set color of frame and background.
- Style :set curve mode.(in this sample ,select point-line mode)
- Line :set color,width and style of line.
- Point : set color,width and style of point.

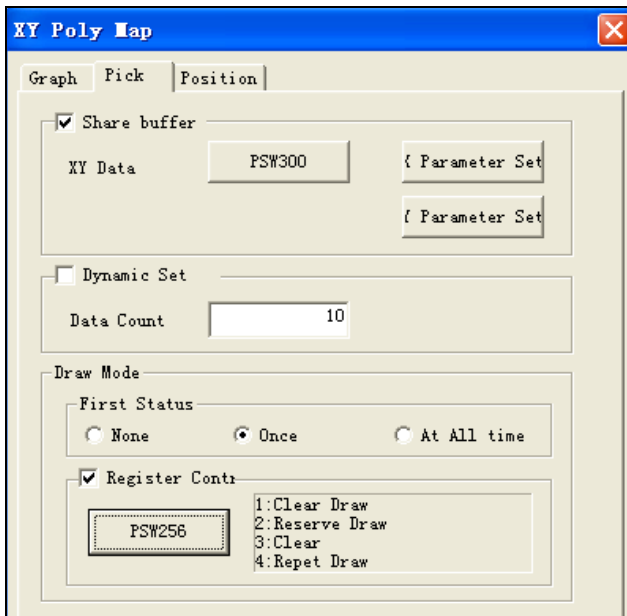

Diagram 3

- XY data:data source is from one area or not.(in this example,'share buffer'is selected and from register PSW300 which means the first dot Xvalue is from PSW300,and Y value is from PSW301,and so on.)
- Data count:the count of points on curve,(when 'dynamic buffer'is selected,it means that data count is based on the referenced register value)
- First value: set the initial mode of curve:
 - None: do no draw automatcially.
 - Once :only draw once at intinal values .
 - At all time :draw curve all the time.

● Register control:do the operation based on the value of referenced reister,there are four operation can be selected.

- 1:clear draw:clear all previous records and draw new one.
- 2:reserve draw: reserve all previous and draw new one.
- 3:Clear: clear all records.
- 4:Repet draw: repeat draw continuously instead old ones.

Click 'grid control'  from toolbar and set property as below:

This component used in this sample is for data investigation,but please note it is not necessary for

application of component 'sample save'.

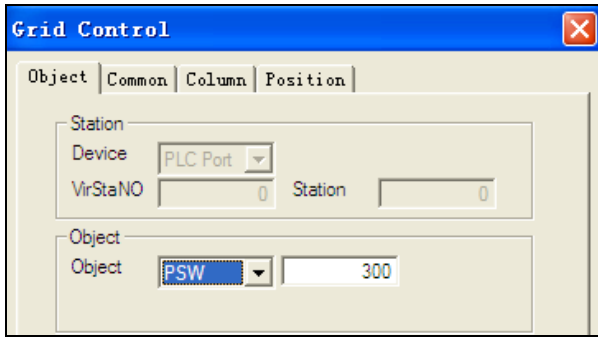

Diagram 4

- Object :PSW300(beginning address as data source)

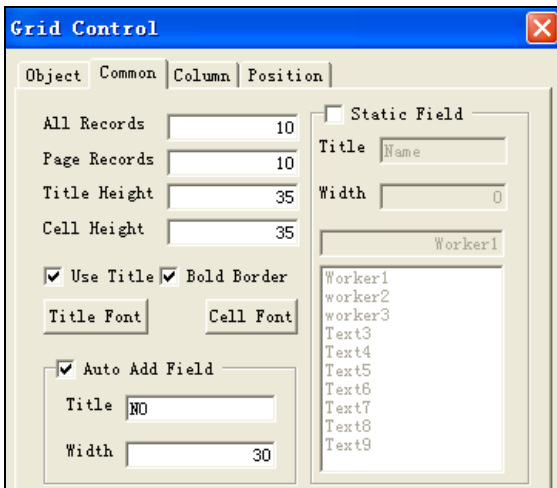

Diagram 5

- All records:10
- Page records:10
- Static field:not use

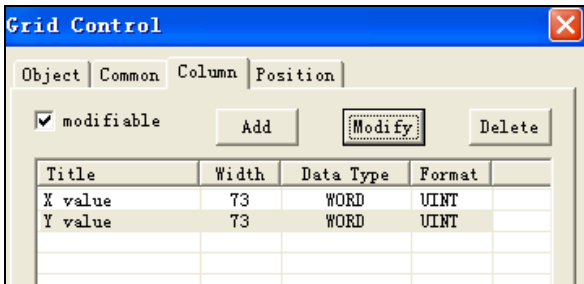

Diagram 6

- Add/modify/Delete:add to 2 columns.

After above components are finished ,please use 'emulator offline'to investigate the run status.

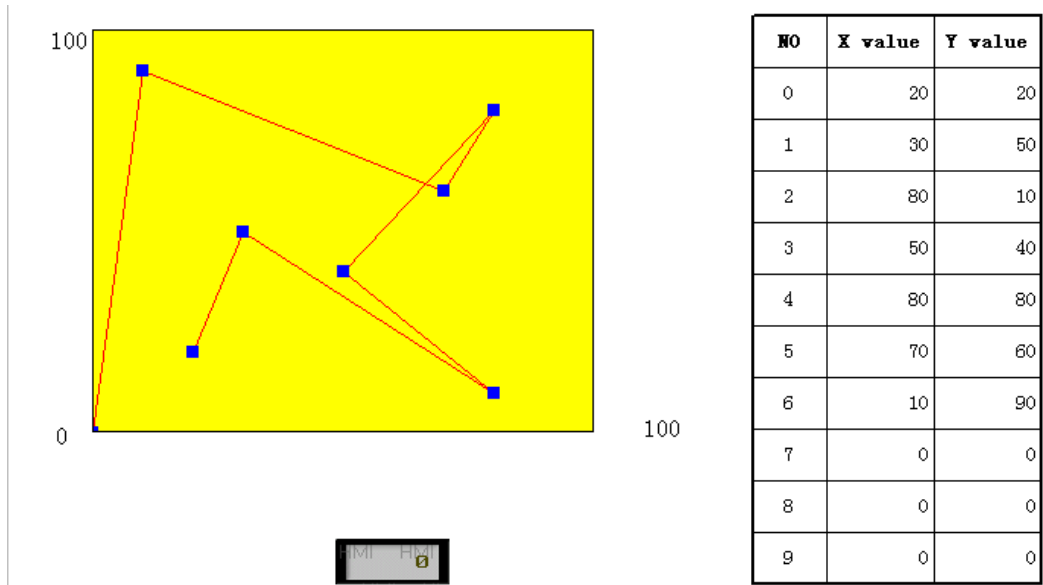
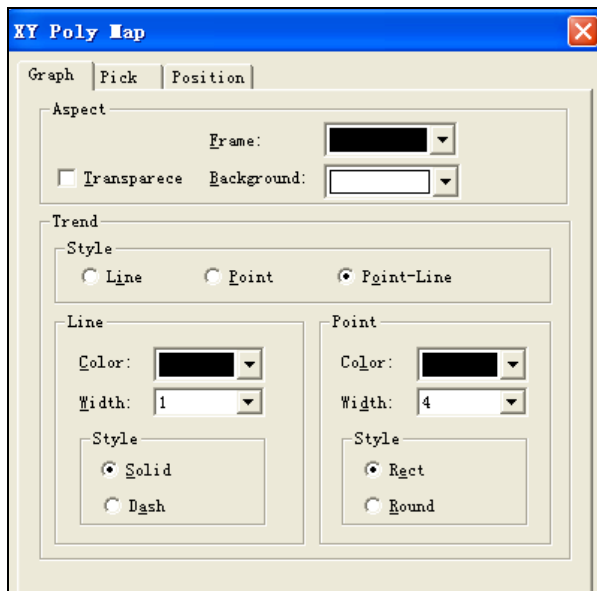

Diagram 7

10.3 Description of parameter setting.

Property of 'Graph'



Parameters	Description
spect	set color of frame and background.
Style	set curve mode.(in this sample ,select point-line mode)
Line	set color,width and style of line.
Point	set color,width and style of point.

Property of 'pick'



Parameters	Description
XY data:	data source is from one area or not.
Data count	the count of points on curve,(when 'dynamic buffer'is selected,it means that data count is based on the referenced register value)
First value	set the initial mode of curve None: do no draw automatcially. Once :only draw once at intinal values . At all time :draw curve all the time.
Register control	do the operation based on the value of referenced reister,there are four operation can be selected. 1:clear draw:clear all previous records and draw new one. 2:reserve draw: reserve all previous and draw new one. 3:Clear: clear all records. 4:Repet draw: repeat draw continuously instead old ones.

11 Import CSVdata

11.1 Introduction

This function supports data import from U-disk to TH series touch panels in CSV format, bringing convenient data analyse and update with software or other devices.

● Please pay attention to the following information:

1. Title in CSV files can not be imported with other information.
2. CSV files can be produced by touch panels, EXCEL and other ways.

11.2 Description

Example 1

Import data from CSV files which has the following features:

1. This CSV file is produced by touch panels as filename: TH.CSV.
2. This CSV file is in 'liner' mode with '5*5' array.



Other components included in this example please refer to the 'Basic manual for touch panels'.get from website "<http://www.xinje.com>

Click 'function button' from toolbar and add 'Import CSV data' as below:

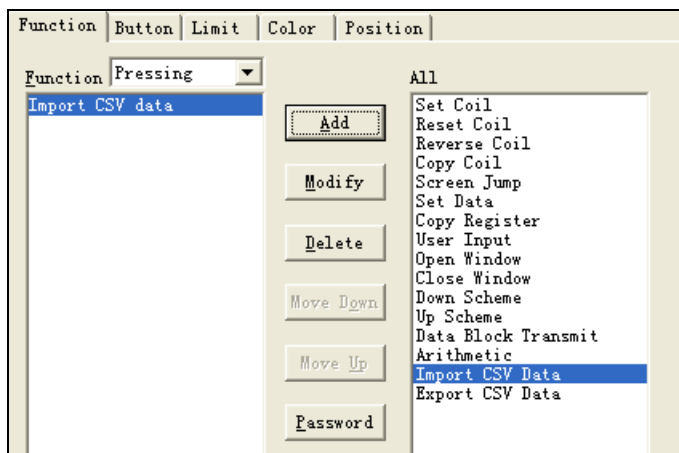

Diagram 1

Property of 'Import CSV data'

- Function: select 'Pressing'.
- Add/Modify: click 'import CSV data' from 'all' list and click 'Add', then click 'modify' key to set its property

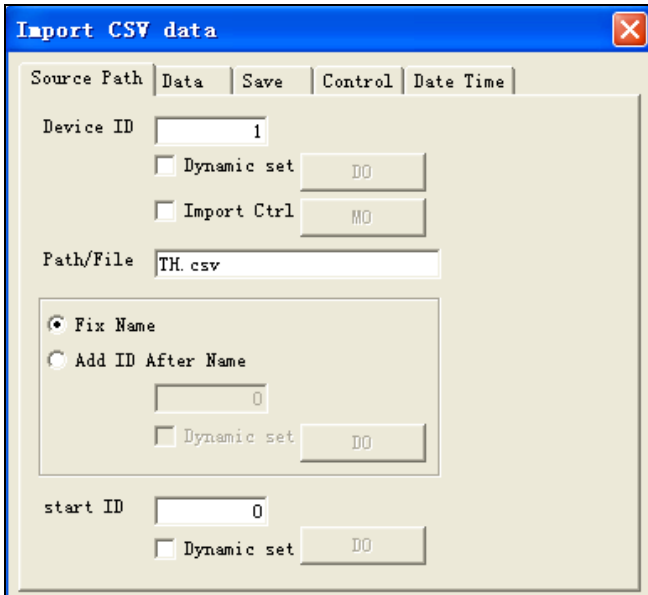

Diagram 2

- Device ID: the ID of U.disk when there are more than one disk. ID can be set by manual or dynamic register .
- Import control: import operation is allowed when referenced coil is set,otherwise ,import is forbidden.
- Path/File:name of import CSV file.
- Add ID after name:select file according to file name and ID. ID is set by manual or dynamic register.
- Start ID:set the beginning of CSV list for data import, '0' means start from the first line. Aslo start ID can be set by manual and dynamic register.

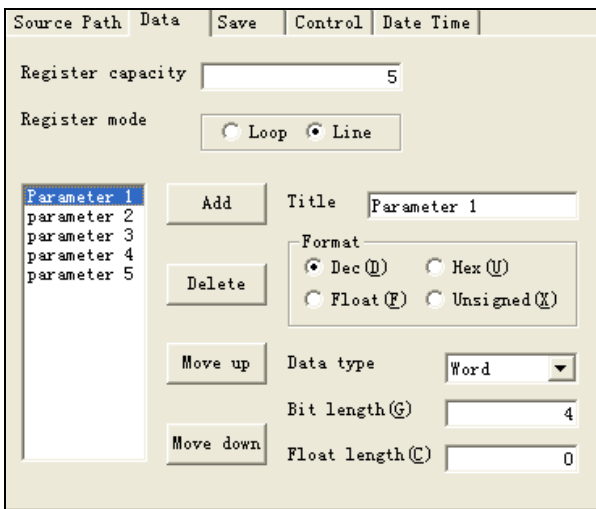

Diagram 3

- Register capacity: amount of groups for data import every time.
- Register mode: set the same mode as 'CSV files'.(In this example, using 'line'. It is adviced to use 'Loop'when mached with 'Real trend map', 'History data map', 'Time trend map'and 'sample save' components.)
- Add/Delete:add or delete import inforamtion.
- Move up/Move down: change the sequence of column information.
- Title:set the column title.
- Format: set same format as 'CSV files'.
- Data type: set same format as 'CSV files'.

- Bit length/Float length: set the same format as 'CSV files'.

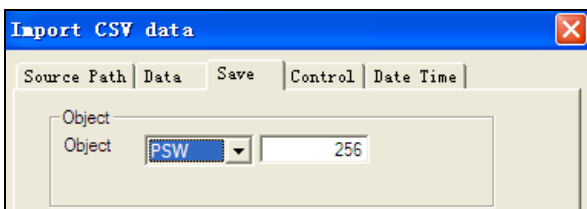

Diagram 4

- Object: the beginning address for data import.

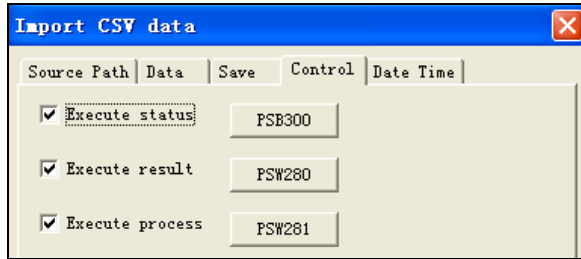

Diagram 5

Meaning based on different value is showed as below:

- 0— Import successfully.
 - 1— Device for import doesn't exist.
 - 2— Memory is not enough
 - 3— Name of path file is incorrect.
 - 4— Read/write file is failed.
- Execute process: show the procedure according to value of referenced register.(range of value is from 0~100,and 100 means finishe import)

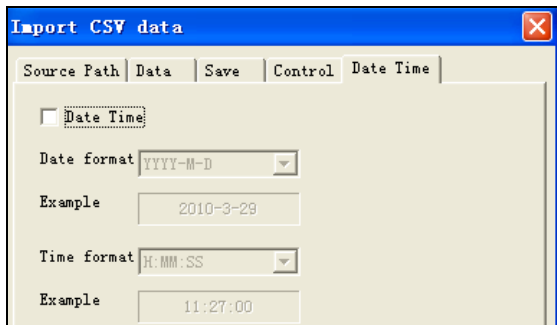

Diagram 6

- Execute status: indicate import status by coil. When coil is on it means it is in import process.

- Execute result: show the result according to value of referenced register.

- Date Time: import data with Date/time information when selected. (in this example, there is no time information, so not select).

- Date format/Time format: select the format in touch panel.

Click component 'grid control'  and set property as below:

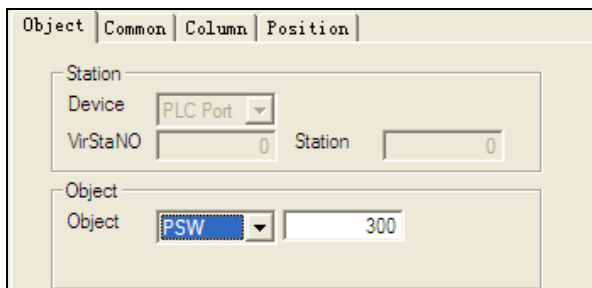

Diagram 7

- Object: PSW300

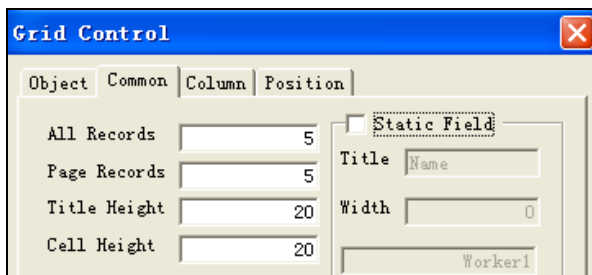

Diagram 8

- All records: 5
- Page records: 5
- Static field: not select

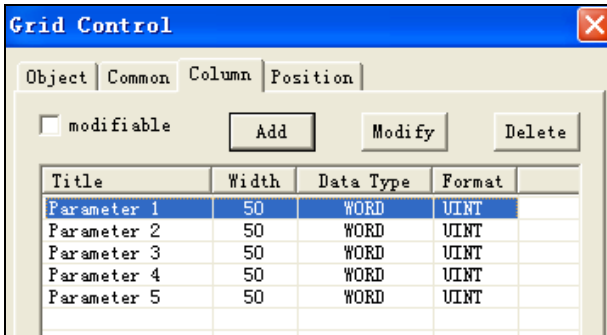

Diagram 9

- Modifiable: not select (in this example only to investigate the imported data)
- Add/Modify/Delete: add to 5 lines information, is showed as left.

click 'lamp'  (one) and 'digital display' (two)  and set property as below:

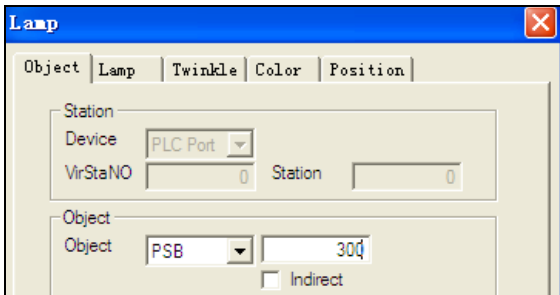

Diagram 10

- Object: PSB300

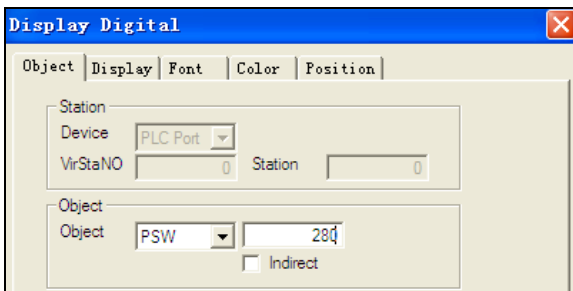

Diagram 11

- Object : PSW280, the other is set PSW281.

After all above components are finished, please download data to panels and investigate whether the data in 'grid control' is consistent with that ones in CSV files.

Example 2:

Import datas from CSV files which has the following features:

- This CSV files is produced by touch panels as filename: TH2.CSV.
- This CSV file is in 'loop' mode with '5*5' array.

Note: the following chapters only describes the different parts compared with example 1.



Other components included in this example please refer to the 'Basic manual for touch panels'. get from website "<http://www.xinje.com>"

Click component 'function button' and add function with 'import CSV data'
 set property of 'import CSV data'

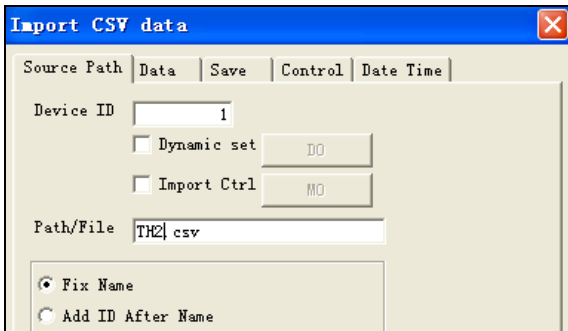

Diagram 12

- Path/file:TH2.CSV

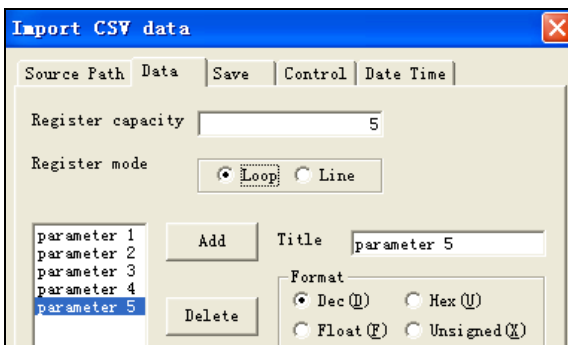

Diagram 13

- Register mode:please select 'loop'(set same format as 'CSV files')

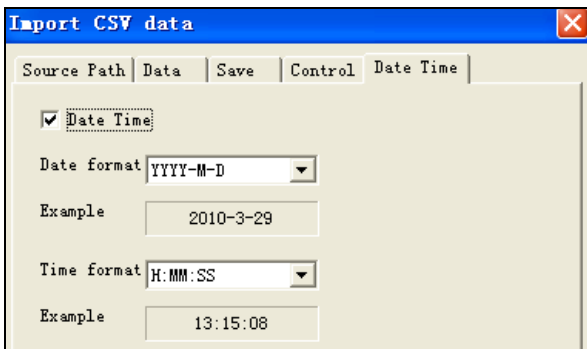



Diagram 14

- Date/time:select(the format is showed as left)

Click 'data grid'  and set property as below:

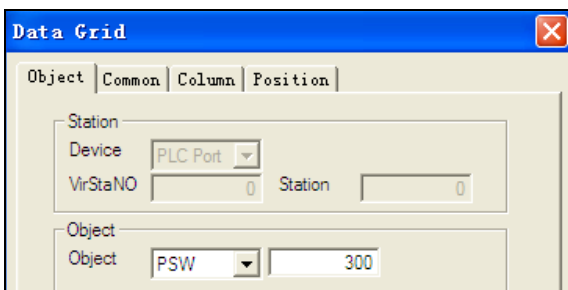

Diagram 15

- Object: PSW300

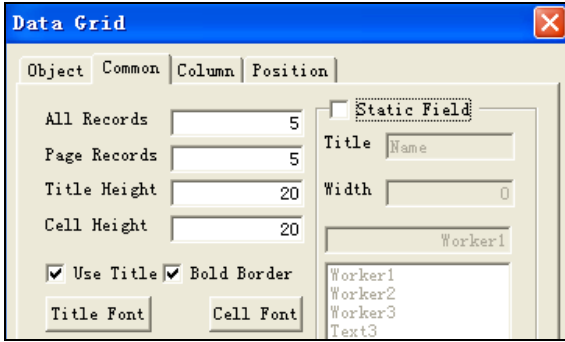

Diagram 16

- All records:5
- Page records:5
- Stactic field :not select.

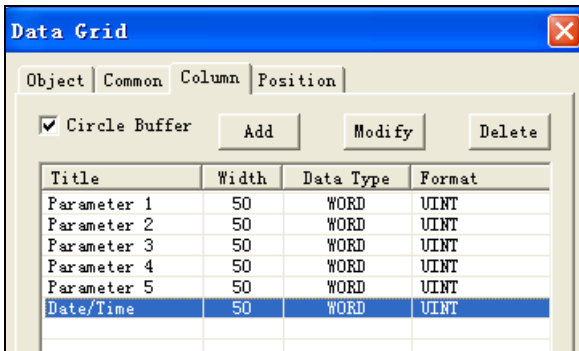



Diagram 17

- Circle buffer: select (set same format as 'CSV files')
- Add/Modify: add to 6 column ,is showed as left.

Click 'lamp' component  (one) and 'digital display'  (two),and set property as same as example 1,then download data to panels to investigate whether the data in 'grid control' is consistent with that ones in CSV files .

11.3 Description of parameter setting.

Property of 'Source path'

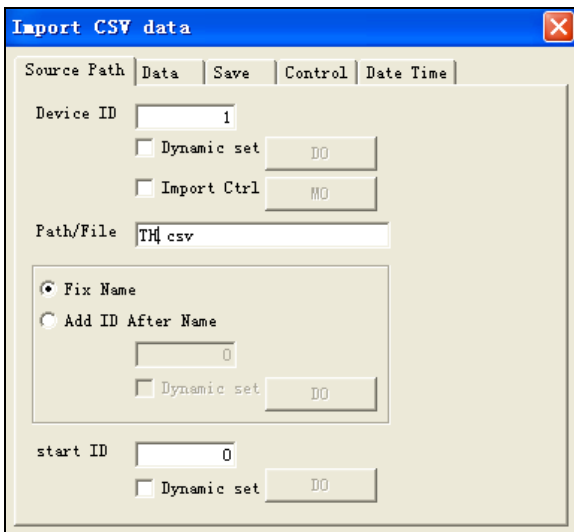

Diagram 18

Parameter	Description
-----------	-------------

Device ID:	the ID of U.disk when there are more than one disk. ID can be set by manual or dynamic register .
Import control:	import operation is allowed when referenced coil is set,otherwise ,import is forbidden.
Path/File	name of import CSV file.
Fix name	Only file name in 'path/file'is active.
Add ID after name	select file according to file name and ID. ID is set by manual or dynamic register.
Start ID:	set the beginning of CSV list for data import, '0'means start from the first line. Aslo start ID can be set by manual and dynamic register.

Property of 'data'

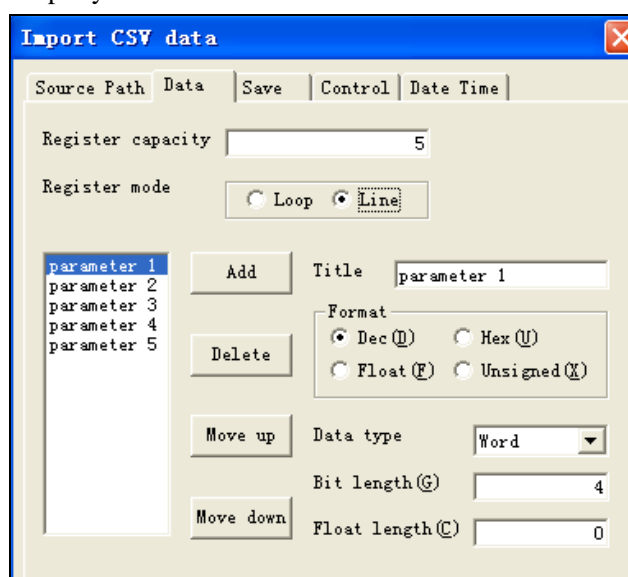

Diagram 19

Parameter	Description
Register capacity	mount of groups for data import every time.
Register mode	set the same mode as 'CSV files'.(In this example, using 'line'. It is adviced to use 'Loop'when mached with 'Real trend map'. 'History data map', 'Time trend map'and 'sample save' components.)
Add/Delete	add or delete import inforamtion
Move up/Move down:	change the sequence of column information
Title	set the column title
Format:	set same format as 'CSV files'
Data type	set same format as 'CSV files'

Property of save

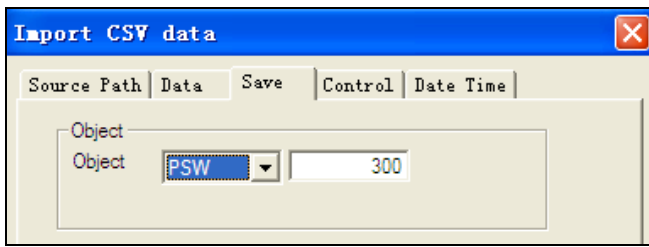

Diagram 20

Parameter	Description
Object	Beginning address for data import.

Property of 'control':

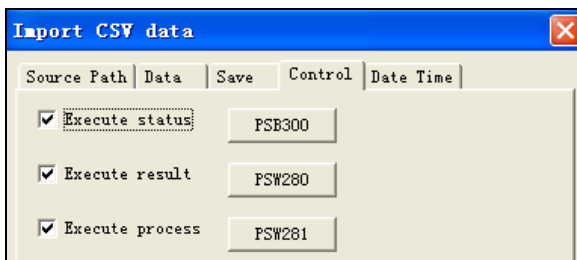

Diagram 21

Parameter	Description
Execute status	indicate import status by coil. When coil is on it means it is in import process.
Excute result	show the result according to value of referenced register Meaning based on different value is showed as below: 1-- Import successfully. 2-- Device for import doesn't exist. 3-- Memory is not enough 4--Name of path file is incorrect. 5--Read/write file is failed
Execute process	show the procedure according to value of referenced register.(range of value is from 0~100,and 100 means finishe import)

Property of 'Date/time'

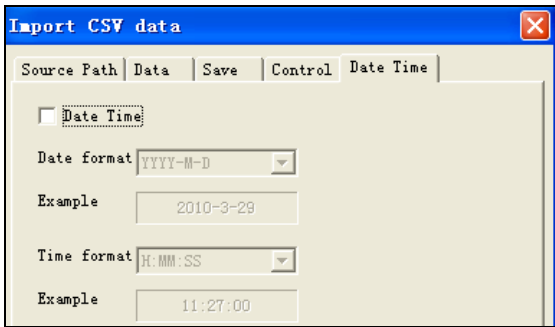

Diagram 22

Parameter	Description
Date Time	Import data with Date/time information when selected.(in this example,there is no time information ,so not select).
Date format/Time format	select the format in touch panel.

12 Export CSV data

12.1 Introduction

This function is used to export data from U-disk to TH series touch panels with CSV format which can be opened and edited by EXCEL software.

Based on this function ,the save space can be extended to keep available datas with flexibility.

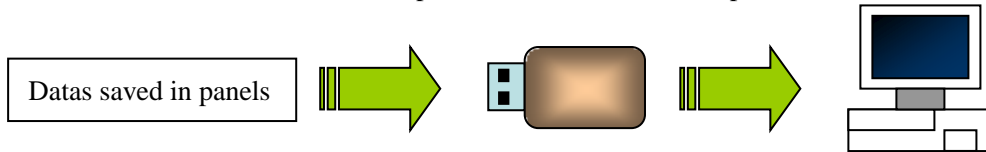

Diagram 1

12.2 Description

Example1

This chapter describes setting and operation of data export with 'grid control as data source'.

Component 'grid control 'has following features:

1. Beginning address PSW300,
2. 5*5 array,take up 25 registers.



Other components included in this example please refer to the 'Basic manual for touch panels'.get from website"<http://www.xinje.com>

Click component 'grid control'  and set property as below:

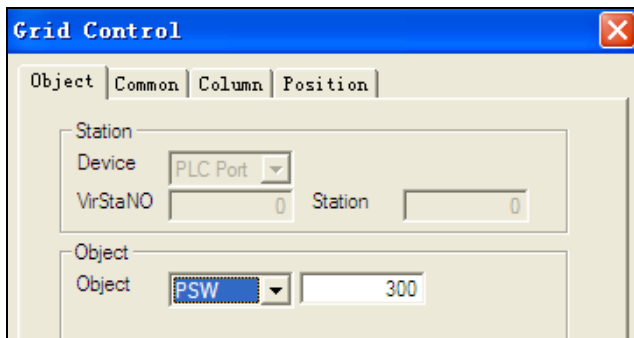

- Object: PSW300

Diagram 2

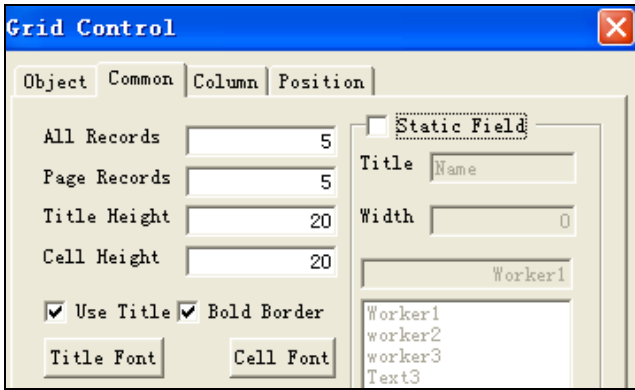

- All records:5
- Page Records:5
- Static Field:not select

Diagram 3

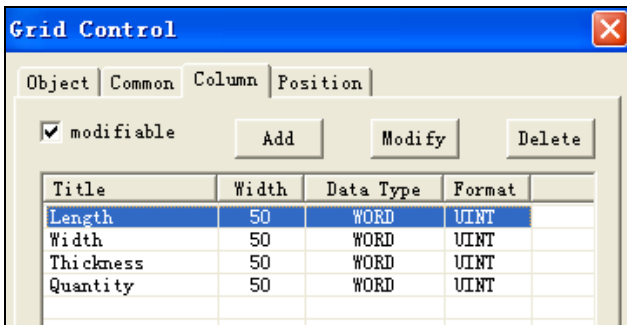

- Modifiable: select
- Add/Modify/Delete:add to 5columns

Diagram 4

click component 'function button'  and add function 'export CSV data'

Note: both 'function button' and 'function field' support 'export CSV data', aslo setting is same ,in this example. only describes procedure of 'function button'.

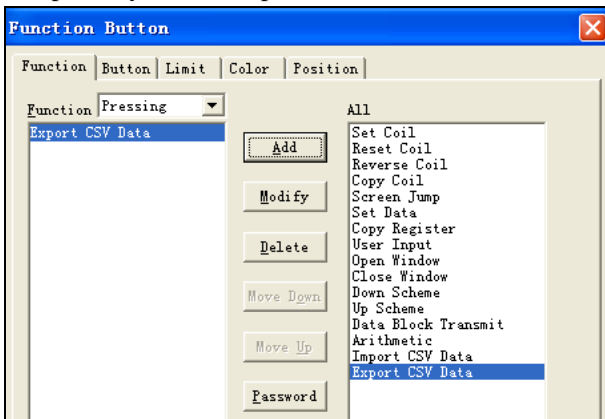

- Function: select 'Pressing'.
- Add/Modify:click 'export CSV data' from 'all' list and click , then click 'modify' key to set its property

Diagram 5

Property of 'export CSV data'

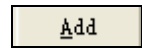
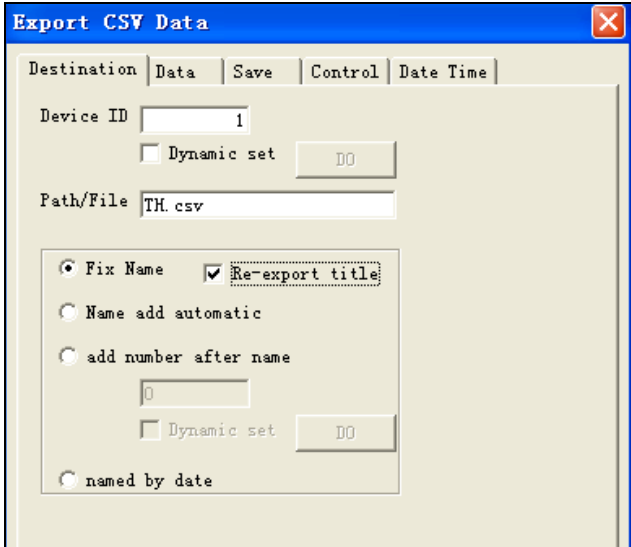

- Device ID: the ID of U.disk when there are more than one disk. ID can be set by manual or dynamic register .
- Path/File: name of export CSV file.
- Fix name: Only file name in 'path/file' is active.
- Re-export title: export data with title information every time. The difference is showed as below:

Diagram 6

	A	B	C	D
1	Length	Width	Thickkness	Quantity
2	40	40	40	40
3	Length	Width	Thickkness	Quantity
4	20	20	20	20

	A	B	C	D
1	Length	Width	Thickkness	Quantity
2	40	40	40	40
3	20	20	20	20
4				

CSV file with 'Re-export title'

CSV file without 'Re-export title'

Diagram 7

- Name add automatic: file name is comprised of name and ID, ID value add 1 automatically by every export operation.(range of ID:000~999),is showed as below:



Diagram 8

- Add number after name: add ID after file name by manual ,or according to the value of dynamic register.
- Named by date:take the current date and time information as file name,once it is selected ,the filename in 'path/file' will not be active,as below:



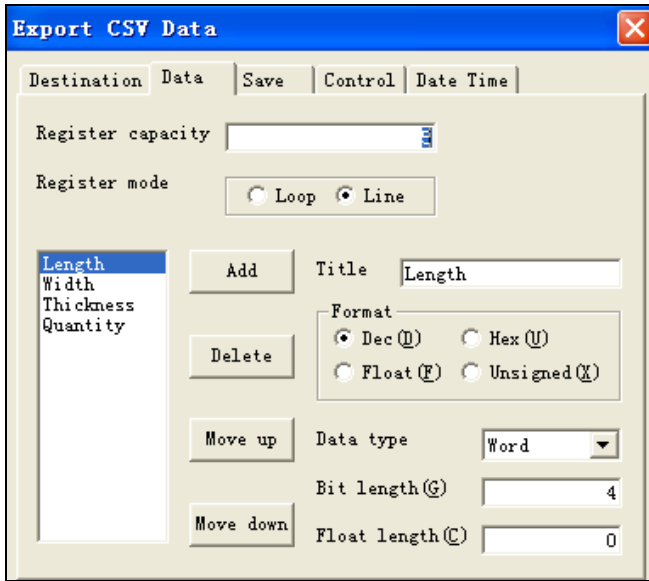

Diagram 9



More details about 'register buffer' please refer to description on component's sample save'parts.

In this example, select register mode with 'line', details regarding 'register buffer' will be described in next chapters.

- Add/Delete: add or delete export information.
- Move up/Move down: change the sequence of column information.
- Title: set the column title.
- Format: set same format as data source.
- Data type: set same format as data source.

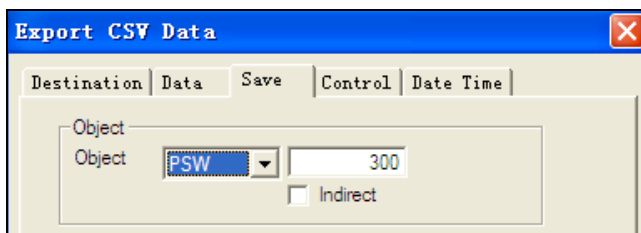

Diagram 10

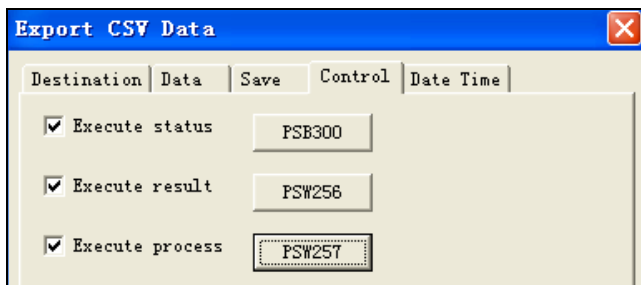

Diagram 11

Meaning based on different value is shown as below:

- Register capacity: amount of groups for data export every time.
- Register mode: check out whether the export data is with 'register buffer' first, if has, select 'loop', otherwise please select 'line'. It is advised to use 'Loop' when matched with 'Real trend map', 'History data map', 'Time trend map' and 'sample save' components.)

- Object :PSW300

- Execute status: indicate export status by coil. When coil is on it means it is in export process.
- Execute result: show the result according to value of referenced register.

- 0- Export successfully.
 - 1- Device for export doesn't exist.
 - 2- Memory is not enough
 - 3- Name of path file is incorrect.
 - 4- Read/write file is failed.
- Execute process: show the procedure according to value of referenced register. (range of value is from 0~100,and 100 means finish export)

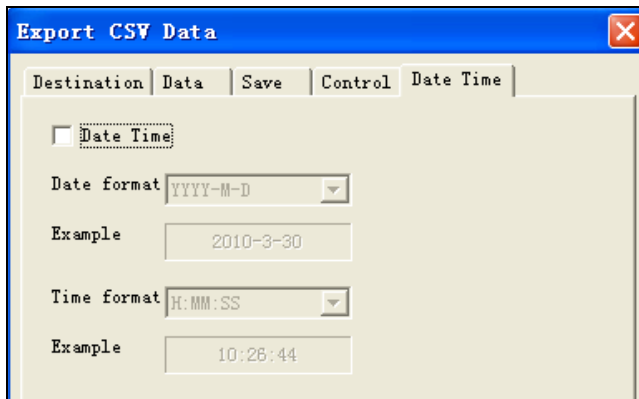



Diagram 12

- Date Time:export data with Date/time information when selected.(in this example,there is no time information ,so not select).
- Date format/Time format:select the format in touch panel.

Click component 'lamp'  (one)and 'digital display'  (two)

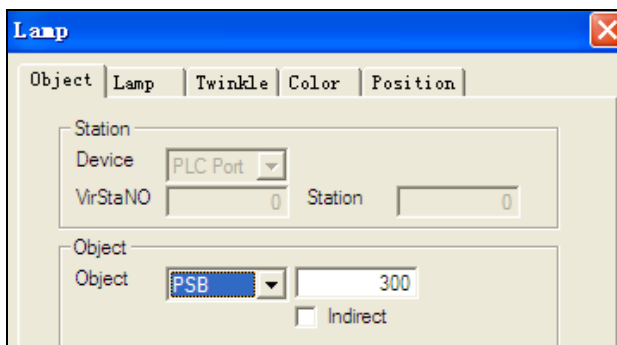

Diagram 13

- Object:PSB300

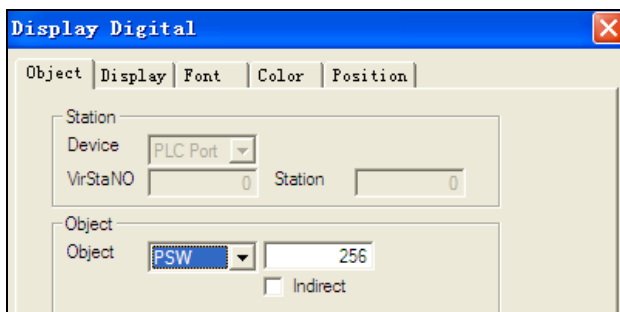

Diagram 14

- Object:one is set with PSW256,the other is set with PSW257.

After all above component is finished ,please install U-disk and test.

G10						
	A	B	C	D	E	F
1	Parameter1	Parameter2	Parameter3	Parameter4	Parameter5	
2	1	2	3	4	5	
3	11	22	33	44	55	
4	111	222	333	444	555	
5	111	222	333	444	555	
6	111	222	333	444	555	
7	Parameter1	Parameter2	Parameter3	Parameter4	Parameter5	
8	1	2	3	4	5	
9	11	22	33	44	55	
10	111	222	333	444	555	
11	111	222	333	444	555	
12	111	222	333	444	555	
13	Parameter1	Parameter2	Parameter3	Parameter4	Parameter5	
14	1	2	3	4	5	
15	11	22	33	44	55	
16	111	222	333	444	555	
17	111	222	333	444	555	
18	111	222	333	444	555	
19						

Diagram 15

Example 2:

This chapter take sample to describe how to set and operate on ‘export CSV data’,matched with ‘sample save ’component from register PSW280 to PSW284.

Note: the following chapters only describes the different parts compared with example 1



Other components included in this example please refer to the ‘Basic manual for touch panels’.get from website“<http://www.xinje.com>

Click component ‘sample save’  and set property as below

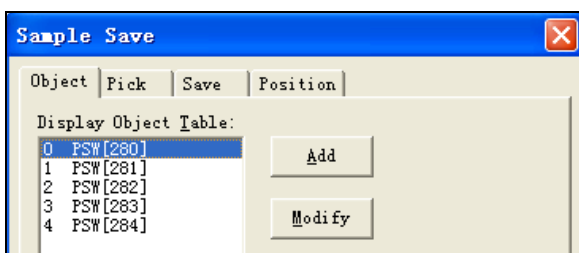

Diagram 16

- Object :add PSW280, PSW281, PSW282, PSW283, PSW284.



- Count:5
- Period:1
- Manner:ymrhms
- PSB280

Diagram 17

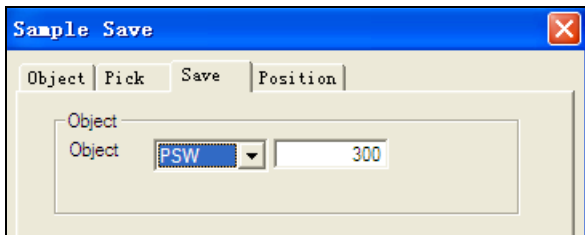

- Object: PSW300

Diagram 18

Click 'grid control'  and set property as below:

Note: 'grid control' is as data source here.

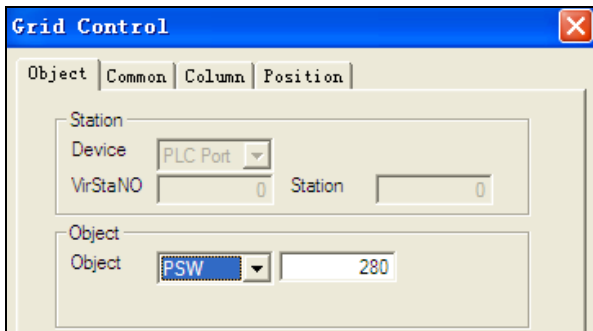

- Object: PSW280

Diagram 19

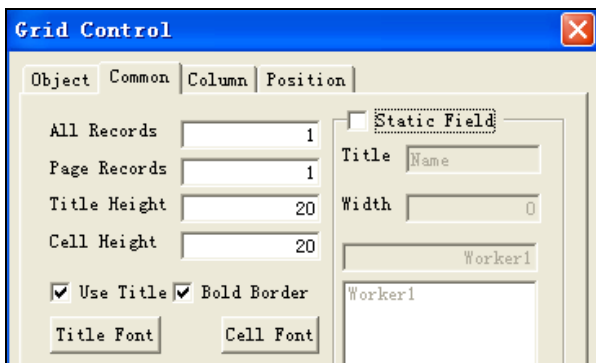

- All records:1
- Page records:1
- Static field: not select

Diagram 20

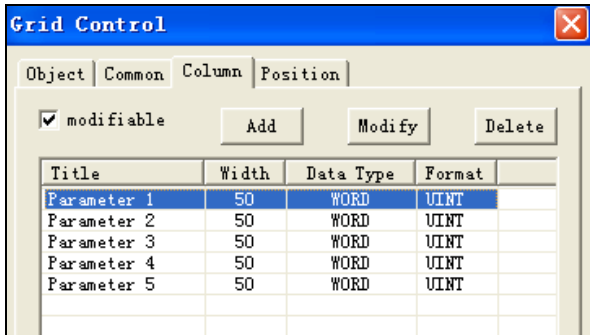



Diagram 21

- Column:add to 5 columns, showed as left.

Click 'function button'  and add function 'export CSV data'

Property of 'export CSV data'

the following chapters only describes the different parts compared with example 1

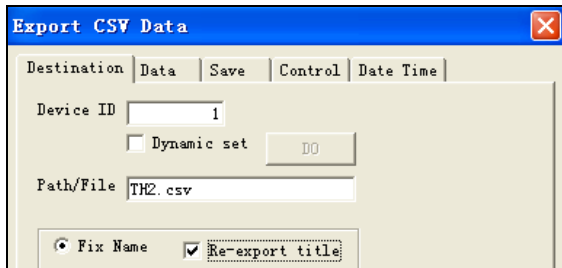

Diagram 22

- Path/File:set as name 'TH2.CSV'

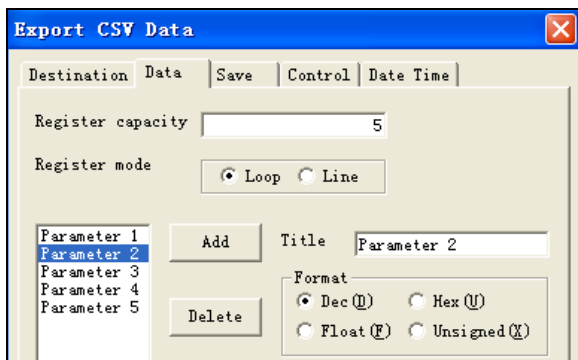

Diagram 23

- Register mode:loop

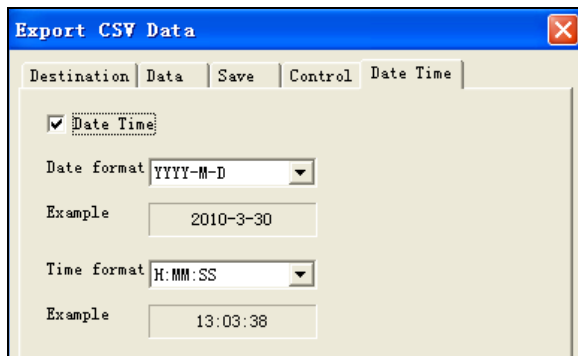

Diagram 24

- Date time: select

After all above component is finished ,please install U-disk to test.

set 'lampbutton'ON ,and input datas in 'grid control'then export CSV datas ,the generated CSV file is showed as below:

	A	B	C	D	E	F	G
1	Parameter1	Parameter2	Parameter3	Parameter4	Parameter5	Date	Time
2	100	200	300	400	500	2009-10-31	9:40:20
3	100	200	300	400	500	2009-10-31	9:40:21
4	100	200	300	400	500	2009-10-31	9:40:22
5	100	200	300	400	500	2009-10-31	9:40:23
6	100	200	300	400	500	2009-10-31	9:40:24
7	Parameter1	Parameter2	Parameter3	Parameter4	Parameter5		
8	100	200	300	400	500	2009-10-31	9:40:25
9	100	200	300	400	500	2009-10-31	9:40:26
10	100	200	300	400	500	2009-10-31	9:40:27
11	100	200	300	400	500	2009-10-31	9:40:28
12	100	200	300	400	500	2009-10-31	9:40:29
13							

Diagram 25

12.3 Description of parameter setting

Property of 'destination'

Diagram 26

Parameter	Description
Device ID:	the ID of U.disk when there are more than one disk. ID can be set by

	manual or dynamic register .
Re-export title	export data with title information every time
Path/File:	Name of export CSV file.
Fix nameOnly	file name i n ‘path/file’is active.
Name add automatic:	file name is comprised of name and ID, ID value add 1 automatically by every export operation.(range of ID:000~999),
Add number after name:	add ID after file name by manual ,or according to the value of dynamiic regiseter
Named by date	take the current date and time information as file name,once it is selected ,the filename in ‘path/file’will not be active,

Property of ‘data’:

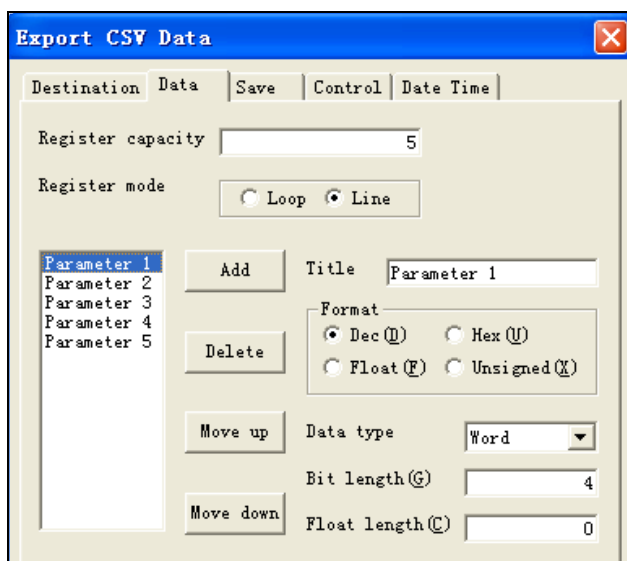

Diagram 27

Parameter	Description
Register capacity	amount of groups for data export every time
Register mode	Register mode:check out whether the export data is with ‘register buffer’ first, if has, select ‘loop’,otherwise please select ‘line’. It is adviced to use‘Loop’when mached with ‘Real trend map’. ‘History data map’, ‘Time trend map’and ‘sample save’ components.)
Add/Delete:	add or delete export inforamtion.
Move up/Move down	change the sequence of column information.
Title	set the column title
Format	set same format as data source.
Data type	set same format as data source.

Property of ‘save’

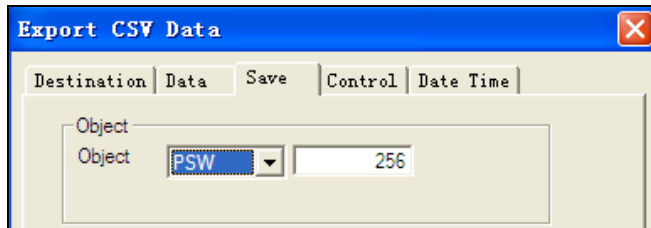

Diagram 28

Parameter	Description
Object	set the beginnning address of data source

Property of 'control'

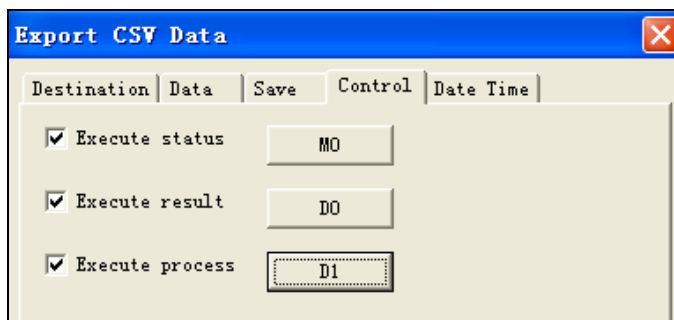

Diagram 29

Parameter	Description
Execute status:	indicate export status by coil. When coil is on it means it is in export process.
Excute result	how the result according to value of referenced register. Meaning based on different value is showed as below: Export successfully. Device for export doesn't exist. Memory is not enough Name of path file is incorrect. Read/write file is failed.
Execute process:	show the procedure according to value of referenced register. (range of value is from 0~100, and 100 means finishe export)

Property of 'Date/time':

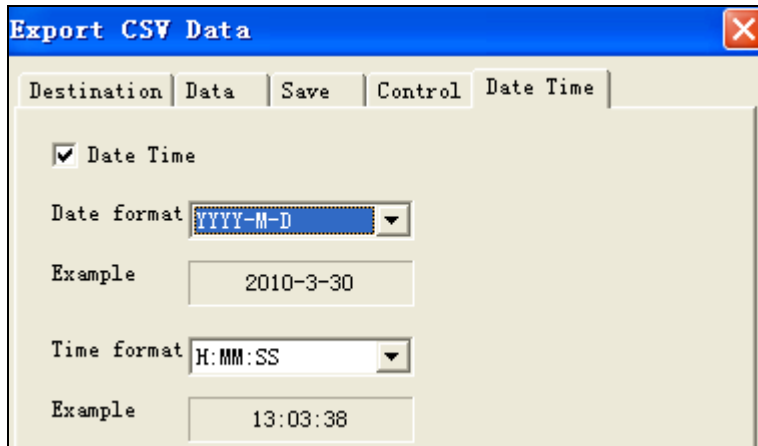

Diagram 30

Parameter	Description
Date Time	export data with Date/time information when selected.
Date format/Time format	select the format in touch panel.

13 Time trend control

This chapter describes how to use 'time trend control'.

13.1 Introduction

This component is used to sample data from destination register at intervals and display value with curve mode.

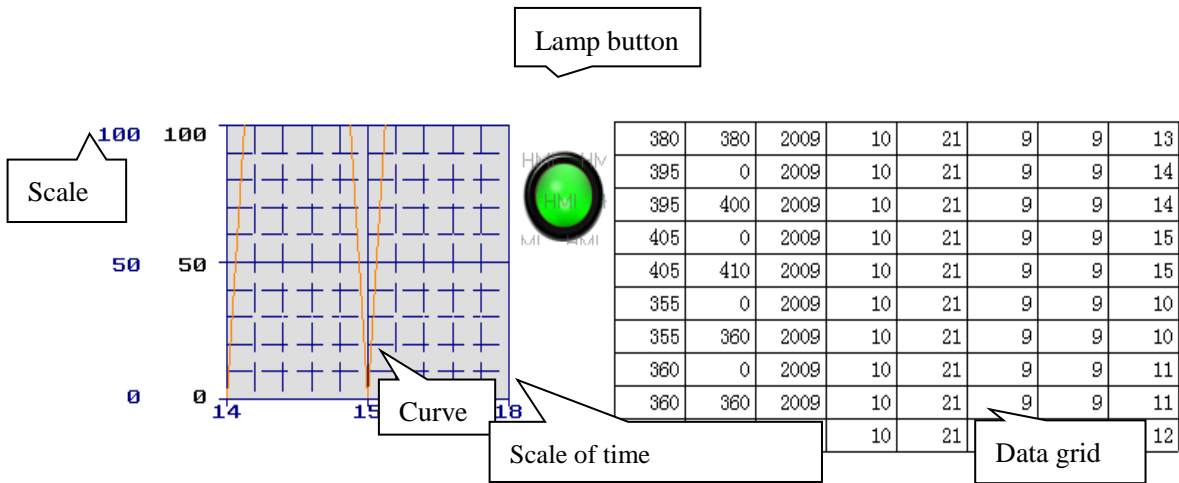

Note: scale can be defined by user, more details please refer to chapter 1.4.

13.2 Procedure

Chapter 13.2.1 describes 'time trend curve' with 'Rotate overwrite' mode;

Chapter 13.2.2 describes 'time trend curve' with 'full stop' mode.

13.2.1 'time trend curve' with 'Rotate overwrite' mode

Step 1. click 'component'

Click component 'time trend curve' , 'lamp button' , 'function field'  and 'data grid'  and

leave them to a suitable position as below.

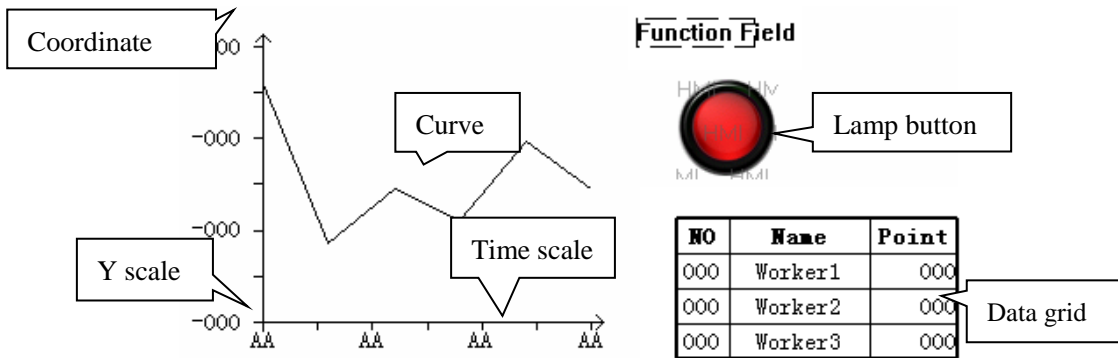

Time trend curve display datas,it is comprised of 4 parts,is showed as below:

- A. coordinate
- B. time scale
- C. Y scale
- D. curve

Button coil used to control ample

Function feild data source

Data grid: display the sampled datas

Step2 view setting on 'time trend curve'

Double-click 'time trend curve' or right-click to set propertu as below:

1) Property of 'common'

Storage Size :10 10;

Storage Mode: rotate overwrite full stop;

Pick Mode: Pick period and with variable mode Variable Mode ;

Other parameter is set as defaulty value

Property contains :common,view,object,trend,color and position
Property of 'common'

Storage Size	<input type="text" value="10"/>
--------------	---------------------------------

Storage size: amount of input datas

Storage Mode	<input checked="" type="radio"/> rotate overwrite	<input type="radio"/> full stop
--------------	---	---------------------------------

Pick mode: contains 'rotate overwrite' mode and 'full stop' mode

Rotate overwrite: sampled datas are saved to destinationed registers in sequence. When it has its full complement ,the new sampled data instead of the old data from the beginning address until new full complement coming, cycles in this rule.

Full stop: sampled datas are saved to destinationed registers in sequence. When it has its full complement ,saving process is stopped



Note :pick mode is available only when storage mode--- 'rotate overwrite' is selected.

Pick mode: contain 'pick period' and 'pick feel'.

Pick period: sample data at fixed intervals.

Period: set period value and unit.

Pick control: start to sample when referenced coil is triggered.

Variable Mode:

The 'fix mode' is in 'stop' mode when 'variable mode' is selected with referenced coil OFF.

The 'fix mode' is in 'circle' mode when 'variable mode' is selected with reference coil ON.

While 'variable mode' is not selected, 'stop' and 'circle' can be selected by user.

Fix mode-stop: sampled data are saved to destination registers in sequence. When it has its full complement, the new sampled data instead of the old data from the beginning address until new full complement coming, cycles in this rule.

Fix mode-circle: sampled data are saved to destination registers in sequence. When it has its full complement, saving process is stopped.

Pick feel: sample action is triggered by rising edge of signal. collect data once at each rising edge. Parameter setting is shown as below:

Pick Mode

Pick Period

Period Seco

Pick Ctrl

Variable Mode

Fix Mode

Stop Circle

Pick Feel

2) Property of 'view'

Grid Sty. Grid Sty:show grid or not,in this

example,grid is selected.

Time Info Year Month Day
 Hour Minute Second

Time inforamtion: set manner of time.In this example, chose 'second'.

Init Time

Initial time: the scale of the initial time. In this example,chose 5 second.

Time Section
Scale

Time section:sections of time axis. In this example,set 2 sections.

Scale: scale of time axis.

Y Section
Scale

Y sections:sections of Y axis.

Scale: scale of Y axis.

The screenshot shows a dialog box titled "Time Trend" with a close button (X) in the top right corner. The dialog has several tabs: "Common", "View", "Object", "Trend", "Color", and "Position". The "Common" tab is selected. The settings are as follows:

- Grid Sty
- Time: Y:
- Time Info: Year, Month, Day, Hour, Minute, Second
- Init Time:
- Time Section:
- Scale:
- Y Section:
- Scale:

Property of 'color' is set as below:



Set color of 'frame ,back, grid and time lable'.

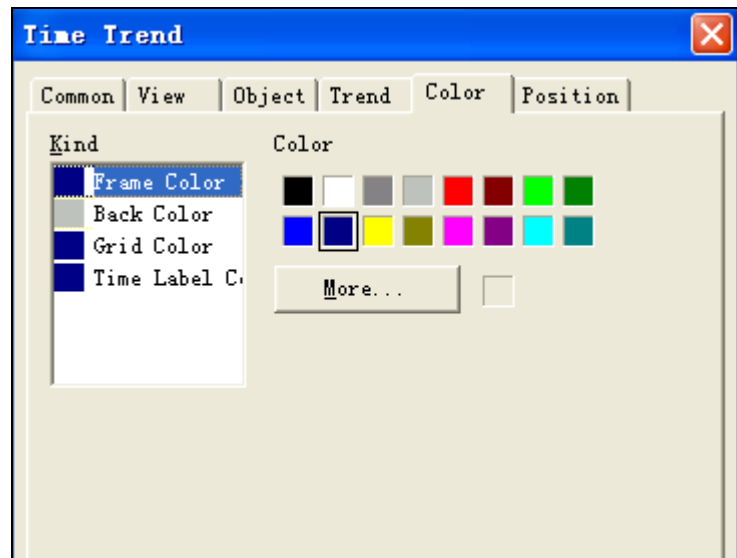

All above setting ,digram is showed as below:

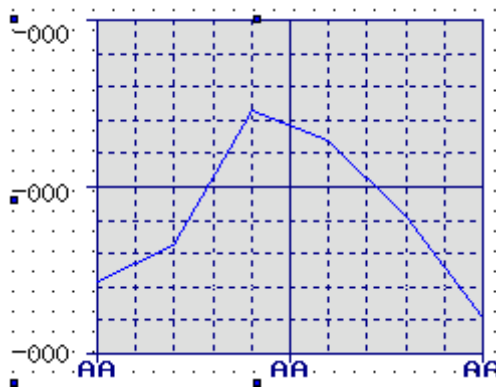

Step 3 setting sample parameters

1) Set property of 'data grid'

Details of parameter setting is showed as below:

Property of 'common': 'user title,bold border, auto add field,static field' are not selected.

All records:10, page records: 10

Property of 'column': add to 7 column, data format of first column is in DEC format. Data format of second column is in Hex format,bitlength is 4, the third,fourth,fifth,sixth and seventh are in HEX format ,and other parameters are default value.

When all above setting is finished, data grid is showed as below:



. . . 000	. . . FFFF	. . . FFF	. . . FFF	. . . FFF	. . . FFF	. . . FFF
. . . 000	. . . FFFF	. . . FFF	. . . FFF	. . . FFF	. . . FFF	. . . FFF
. . . 000	. . . FFFF	. . . FFF	. . . FFF	. . . FFF	. . . FFF	. . . FFF
. . . 000	. . . FFFF	. . . FFF	. . . FFF	. . . FFF	. . . FFF	. . . FFF
. . . 000	. . . FFFF	. . . FFF	. . . FFF	. . . FFF	. . . FFF	. . . FFF
. . . 000	. . . FFFF	. . . FFF	. . . FFF	. . . FFF	. . . FFF	. . . FFF
. . . 000	. . . FFFF	. . . FFF	. . . FFF	. . . FFF	. . . FFF	. . . FFF
. . . 000	. . . FFFF	. . . FFF	. . . FFF	. . . FFF	. . . FFF	. . . FFF
. . . 000	. . . FFFF	. . . FFF	. . . FFF	. . . FFF	. . . FFF	. . . FFF
. . . 000	. . . FFFF	. . . FFF	. . . FFF	. . . FFF	. . . FFF	. . . FFF

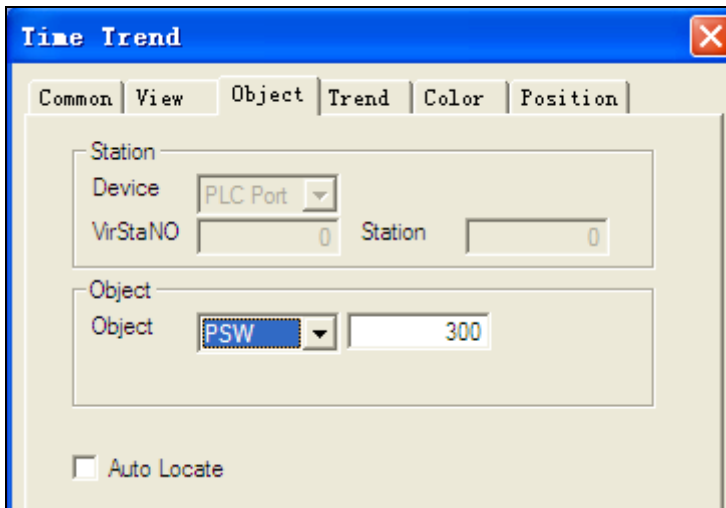

2) Time trend ---parameter setting regarding data sample

Set 'object' property of 'time trend' and set with PSW300

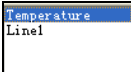

Set property 'trend' of 'time trend' as below:

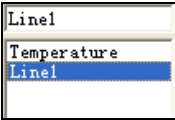
Select , and set color , set **Pick** with , also select 'show scale' **Show Scale**.

Press **Add** to add 'line' , and set color , set **Pick** with , also select 'show scale' **Show Scale**.

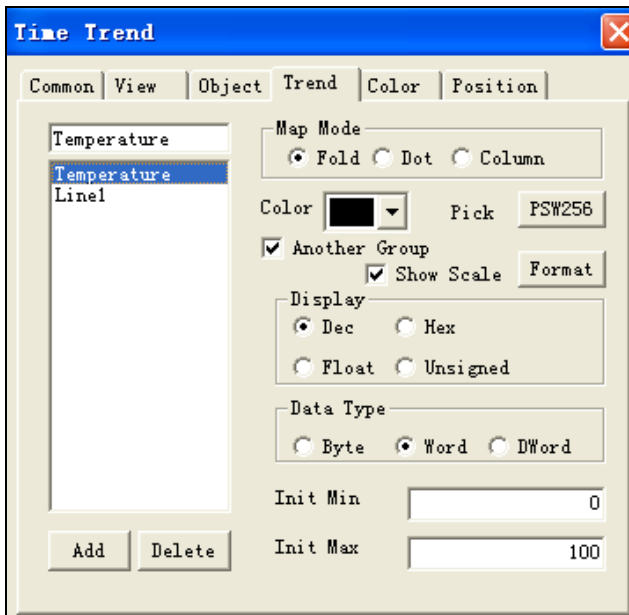

Map mode:

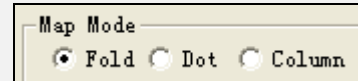

Fold: generate graph in fold format.

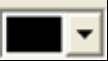

Dot: generate graph in dot format.

Column: generate graph in column format.

Color: : select color you want

Pick : set data source.

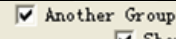
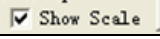
press “  ” to modify object.

Another group   : display Y axis or not. When select ‘show scale’, scale displays and format also can be set by click key 

Set property of ‘data format’ and ‘data type’ as below:

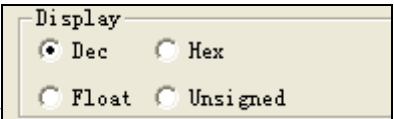
Display : ‘Dec, Hex, Float and unsigned’ four types can be selected.

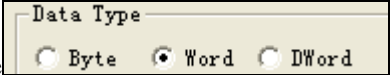
Data type : ‘Byte, Word, Dword’ three types can be selected.

Init Min: the Min value of Y axis.

Init Max: the Max value of Y axis.

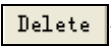

Add or delete graph by press  or  key.

3) Property setting of ‘function field’

Select Time (Sec) mode in ‘act mode’, and add function ‘Arithmetic’:

‘Mode’ property of function field:

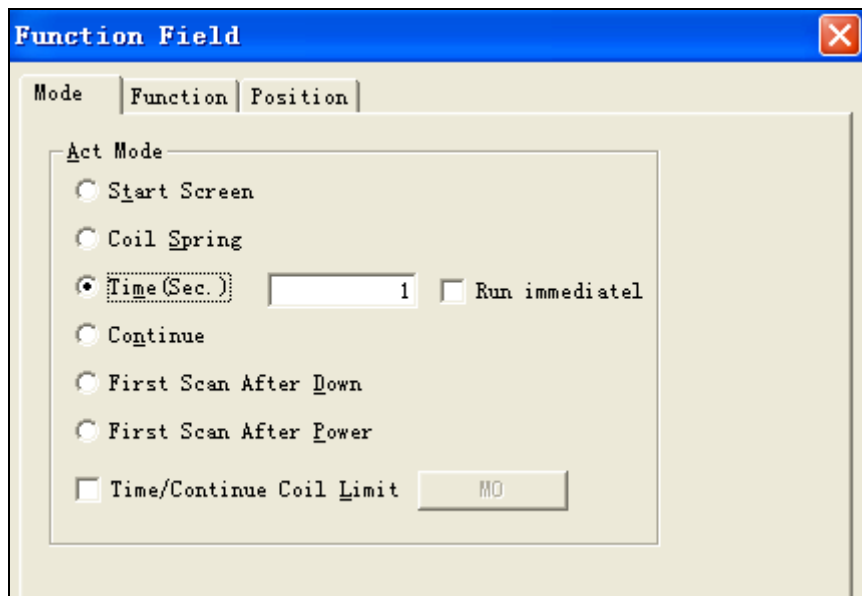

'Function' property of 'function field'

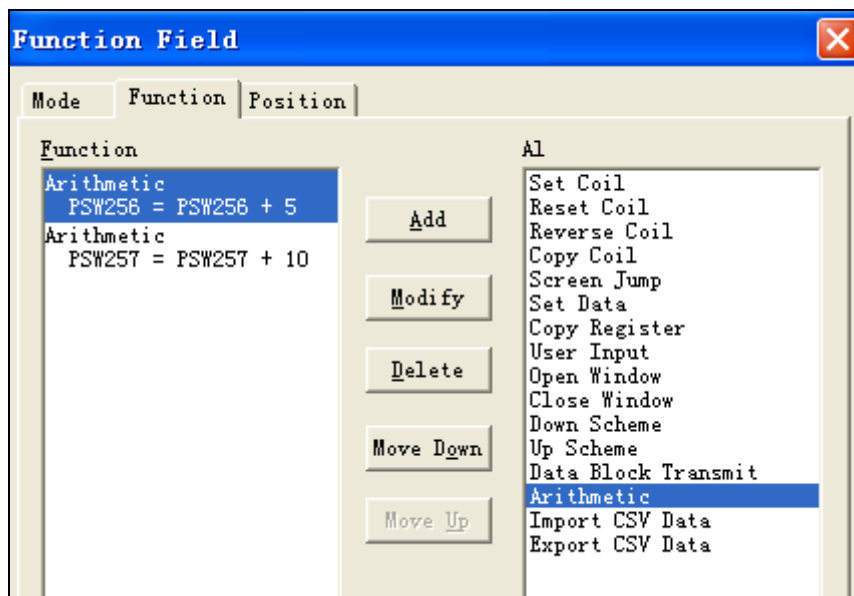

Note: more details regarding 'function field' please refer to <HMI manual Basic>

After all above component is finished, the view of project is showed as below:

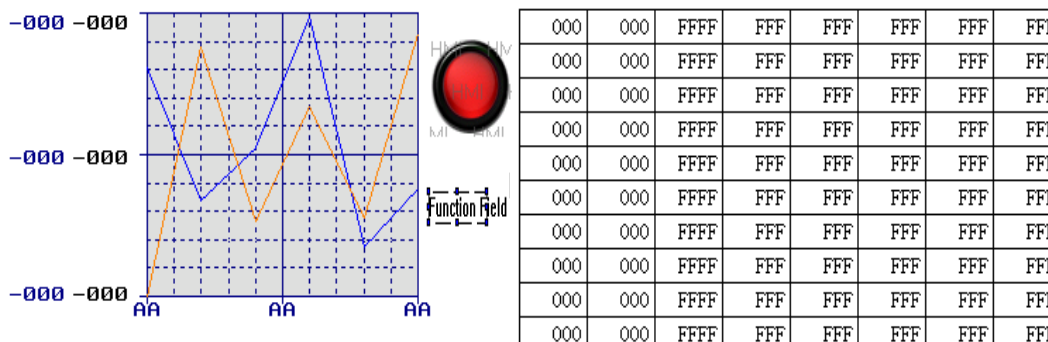

The result by emulator offline:

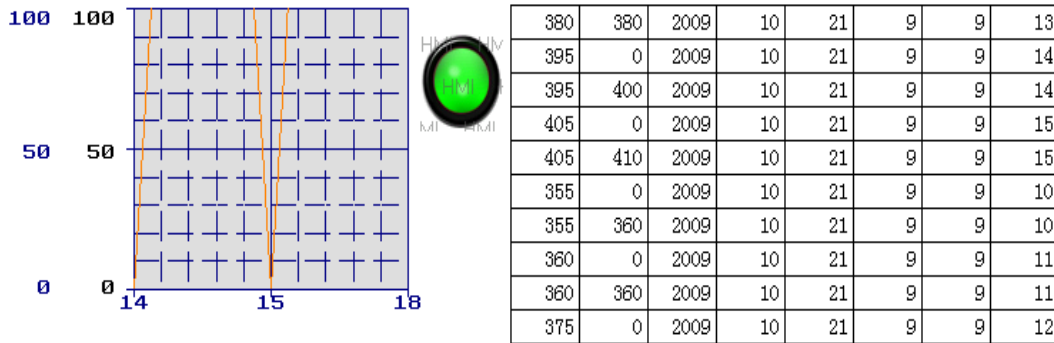

Note: when lamp button is ON , 'time trend is in 'fix mode 'with 'circle',investigate data changing via 'data grid'.

When lamp button is OFF,'time trend'is in 'fix mode' with 'stop',investigate data changing via 'data grid'

13.2.2 'Time trend'with 'stop'mode

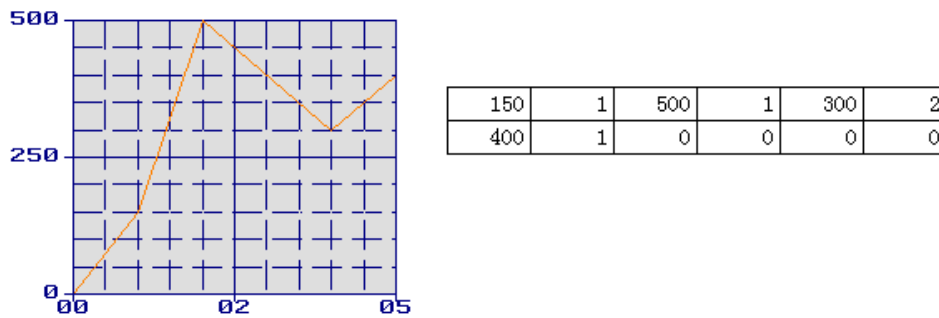

Step1:open a new screen.

Open a new project and add component 'time trend control'and 'grid control' as below:

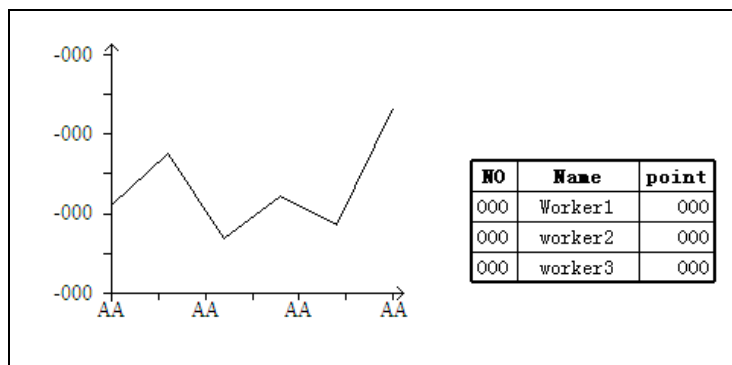

Step2 parameter setting on 'time trend control'

Double-click to set property ,
'common' property



"Storage Size" is set with value 10,

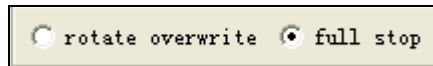

"Storage Mode" is set with 'full stop';

'View' property

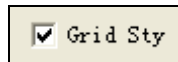

display with 'grid'



is set with '5 second'.



time section is set with 2, and scale is set with 1.



Y section is set with 2, and scale is set with 1. other is set as

default value.

'Object' property:



Object is set with PSW260 and other parameters are set with

default value.

'Trend' property:

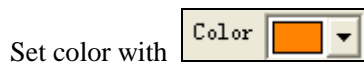

Set color with

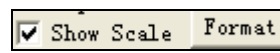

also show scale, other parameters are set in

default value.

'color' property



others are set with default value:

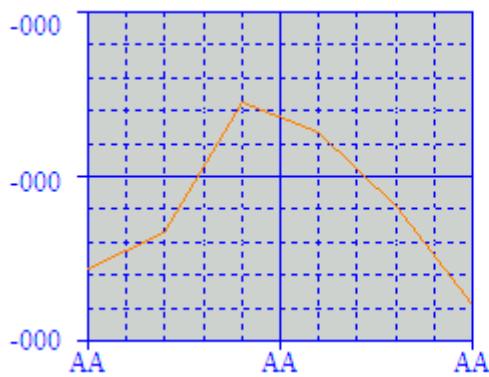

NO	Name	point
000	Worker1	000
000	worker2	000
000	worker3	000

Step3:parameter setting with ‘grid control’

Double-click to set property

‘Object’ property: set object with PSW260, others keep in default value.

‘Common property’:

set all records with value ‘2’, and page value with value ‘2’, other setting containing ‘user title’ Use Title, bold border Bold Border, static field Static Field, auto add field Auto Add Field, are all not selected,

‘Column property’: add to 5 column, others are kept in default value

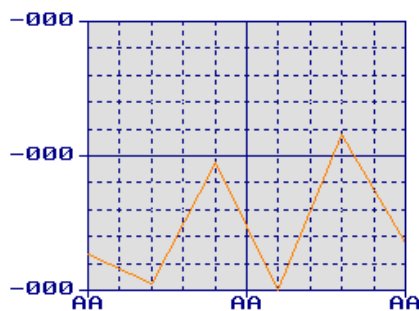

000	000	000	000	000	000
000	000	000	000	000	000

he reslut after emultor offline is showed as below:

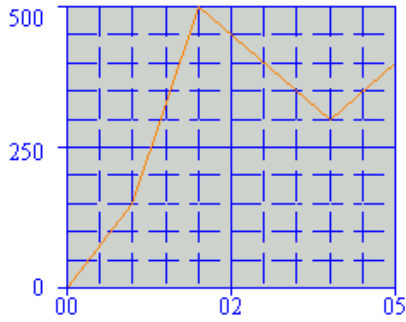

150	1	500	1	300	2
400	1	0	0	0	0

Note: after entering the above datas in ‘data control’,the curve is showed as above.

The first data you enter is the Y value ,the second data is the time ,the following data is arranged in this rule.

13.3 Description of parameters

Property of ‘time trend control’ contains ‘common,view,object,trend,color and position’five items.

1) Property of ‘Common’

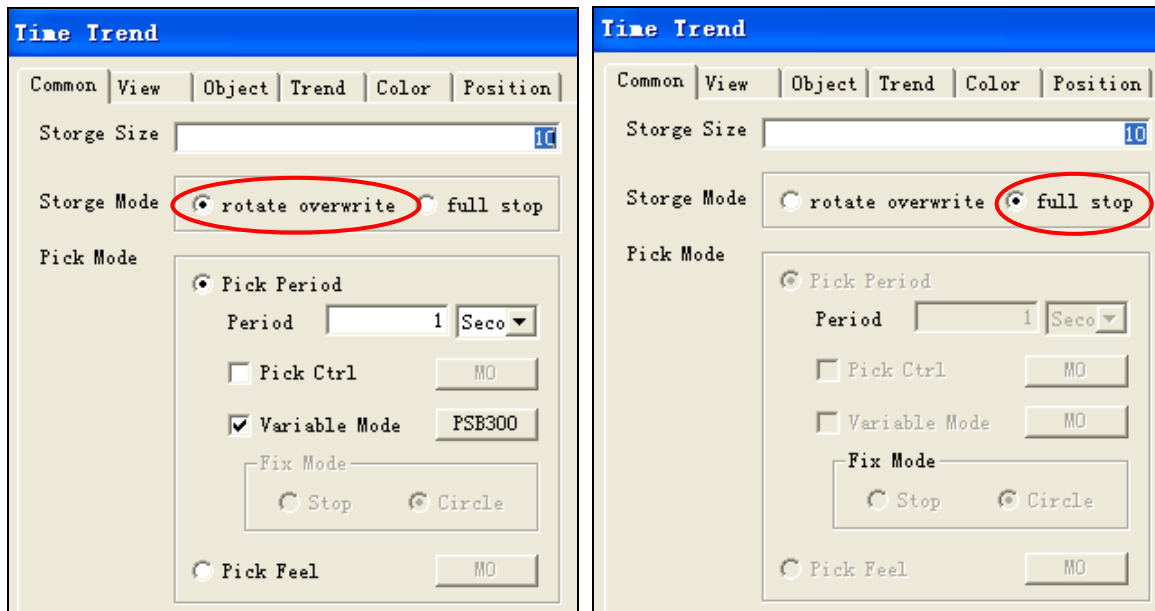

Parameter	Description
Storage Size	input amount of datas

Storge Mode	<p>Rotate overwrite :sampled datas are saved to destinationed registers in sequence. When it has its full complement ,the new sampled data instead of the old data from the beginning address until new full complement coming, cycles in this rule.</p> <p>Full stop: sampled datas are saved to destinationed registers in sequence. When it has its full complement ,saving process is stopped</p>		
Pick mode Note: be available under 'rotate overwrite' mode	Pick mode: contains 'rotate overwrite' mode and 'full stop'mode		
	Pick period	sample data at fixed intervals.	
		Period	set period value and unit
		Pick control	start to sample when referenced coil is triggered
		Variable Mode	<p>The 'fix mode' is in 'stop'mode when 'variable mode 'is selected with referenced coil OFF.</p> <p>The 'fix mode'is in 'circle'mode when 'variable mode 'is selected with reference coil ON.</p>
Fix mode	<p>While 'variable mode 'is not selected,, 'stop'and 'circle'can be selected by user.</p> <p>Fix mode-stop: sampled datas are saved to destinationed registers in sequence. When it has its full complement ,the new sampled data instead of the old data from the beginning address until new full complement coming, cycles in this rule.</p> <p>Fix mode-circle: sampled datas are saved to destinationed registers in sequence. When it has its full complement ,saving process is stopped.</p>		
Pick feel	sample action is triggered by rising edge of signal.collect data once at each rising edge		

2) Property of 'view'

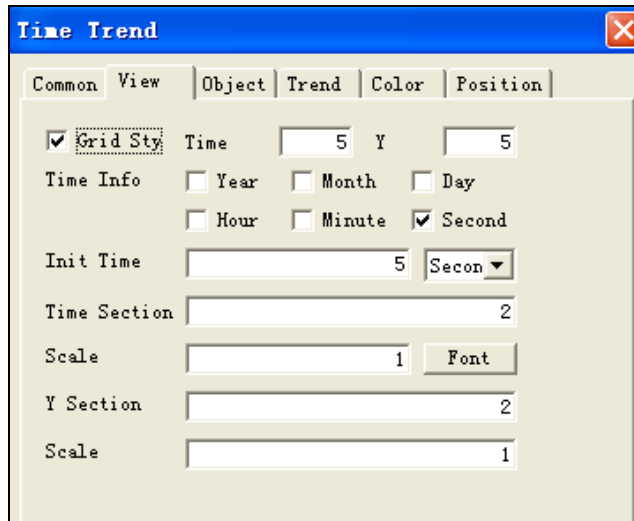

Parameter	Description
Grid Sty	show grid or not
Time informtion	set manner of time.
Initial time	the scale of the initial time
Time section	sections of time axis
Scale	scale of time axis
Y sections	sections of Y axis
Scale	scale of Y axis

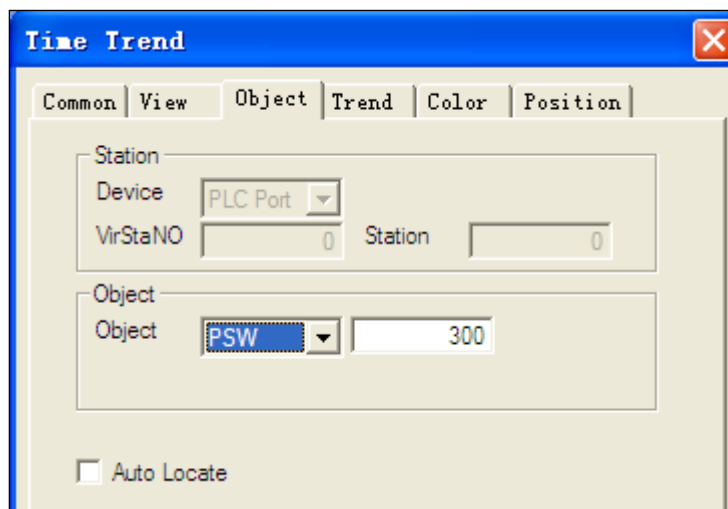

3) Property of 'object'

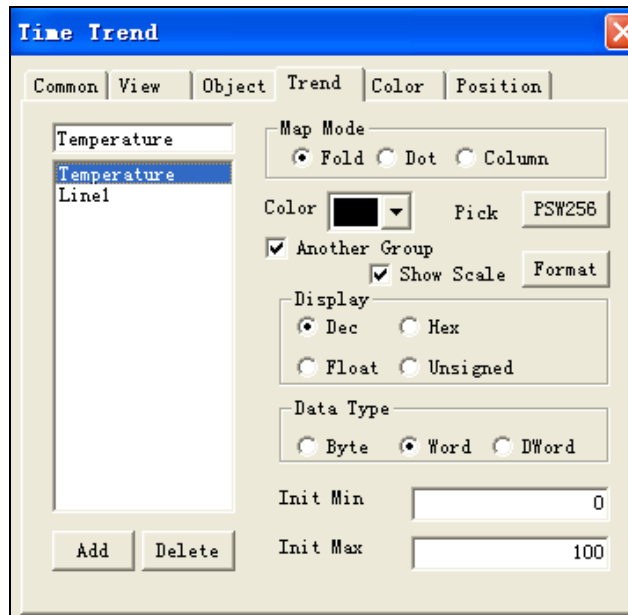

Parameter	Description
Object	Enter the beginning address ,in this mode, 'auto locate' can not be selected.
Auto Locate	Registers to save datas are arranged automatically.

4) 'Trend'property



Parameter	Description
Map mode	Fold: generate graph in fold format. Dot: generate graph in dot format. Column: generate graph in column format
Color	select color you want
Pick	set data source
Another group	display Y axis or not
show scale	scale displays and format also can be set.
Display	Dec, Hex, Float and unsigned' four types can be selected.
Data type	'Byte, Word, Dword' three types can be selected.
Init Min	the Min value of Y axis
Init Max	the Max value of Y axis
Add /delete	Add or delete graph by press  , or  , key.

14 Move animal

This chapter describes how to use this function.

14.1 Introduction

Component 'move animal' is used to move destination object with other referenced components, otherwise, this component is not available.

14.2 Procedure

14.2.1 Track editing

Step1: create a new project and add component.

Open a new project and click component  from toolbar, then click to confirm the start point of the track, double-click to confirm the end point, is shown as below:

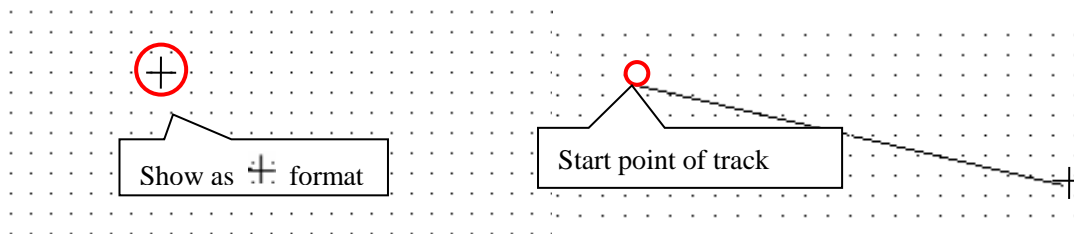

left-click of mouse -----continue to edit track
double-click of mouse-----track editing ends

Step2: set property of text

Click component 'text'  with content 'Move animal', and set set in 'red' color, is shown as below:

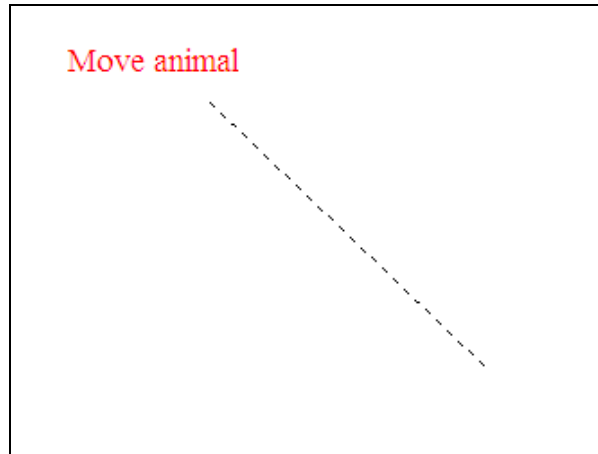

Step3:set property of ‘move animal’

Double-click ‘move animal’ and set property as below:

Key Point:
 X means abscissa;
 Y means ordinate;
 Escape time: time spend to
 move from
 current point to
 next point

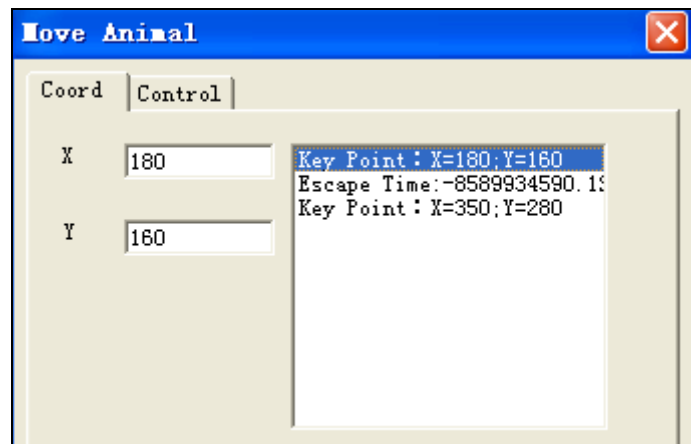

Select ‘Escape time’, as below:

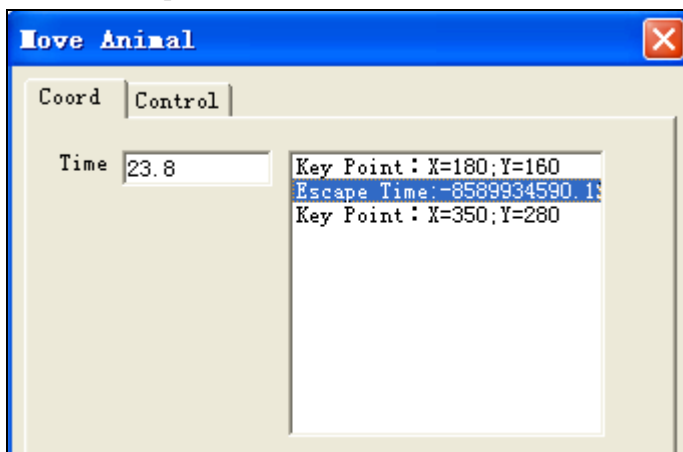

Set the time you want with second as unit,in this example ,we change it to 10 second, is showed ad below:

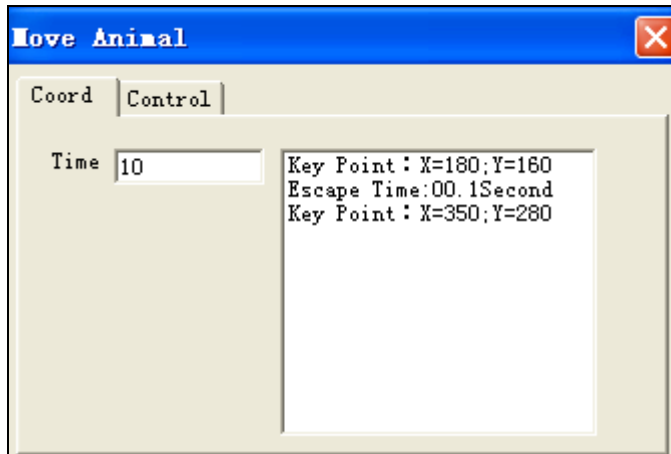

Property of 'Control', is showed as below:

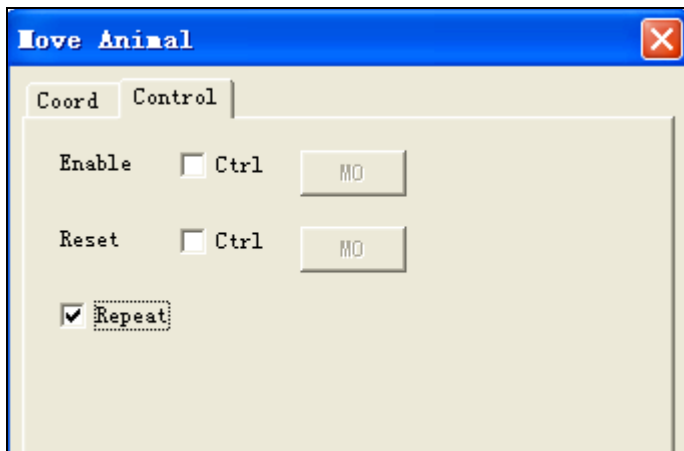

When you want to start the 'move animal 'by a triggered coil,please select 'Enable-control',as below:

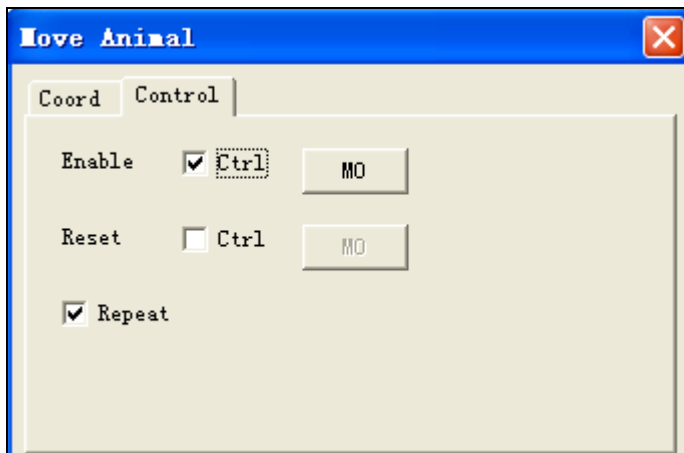

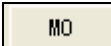
Click key  to set the control address,as below:

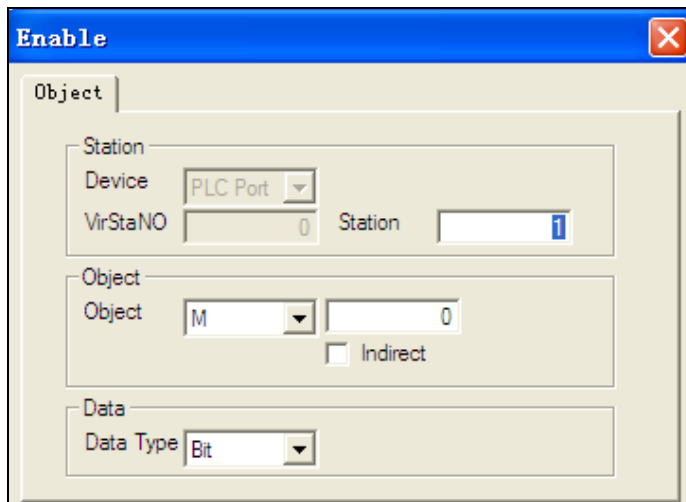

If you want the 'move animal' to return to the beginning point ,please select 'Reset-control',click key  to modify the address.

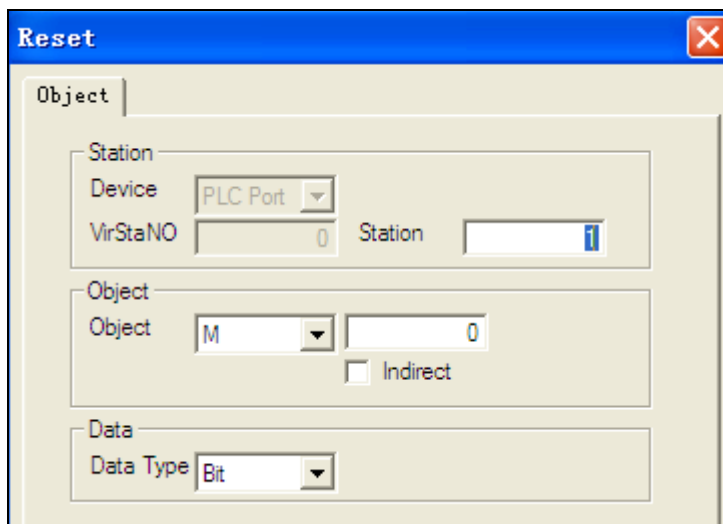

Repeat: move as the track path in circle if this item is selected,if not ,will not repaet movement.

Step4: 'move animal' editing

Select component 'text 'and 'move animal',as below:

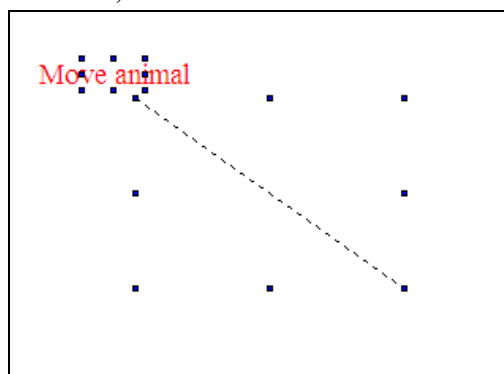

then right-click and select 'group',as below:

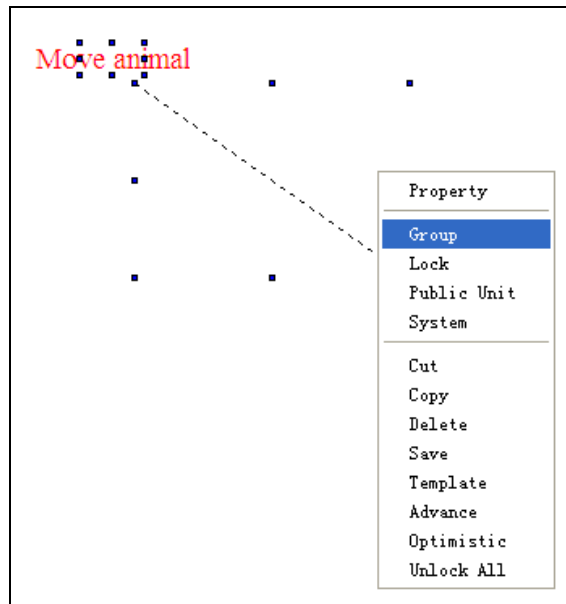

Above is all the procedure of 'move animal'

14.2.2 Example- Scroll text

Step1:creat a new project

Click component 'text'  and with text 'Scroll text edited by move animal',is showed as below:

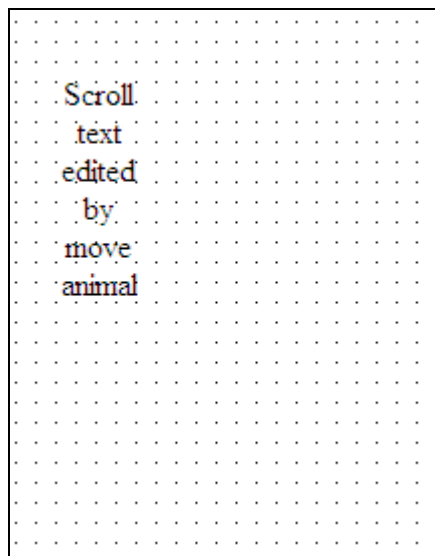

Step2: Creat 'move track'

Click component 'move animal'  from component from toolbar and left-click to confirm the

start point, as below:

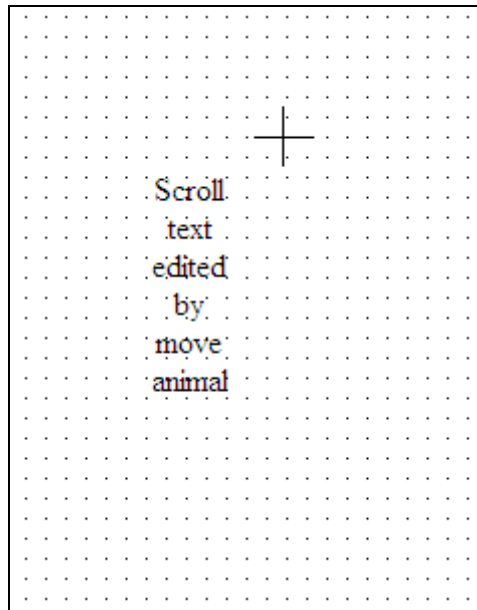

Creat track and double-click to end edit, as below:

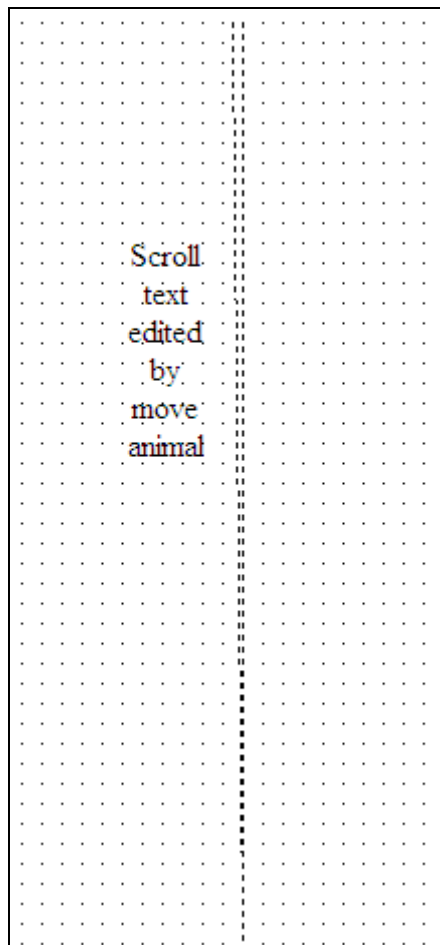

Step3:property setting

Double-click 'text' to set color with 'red', is showed as below:

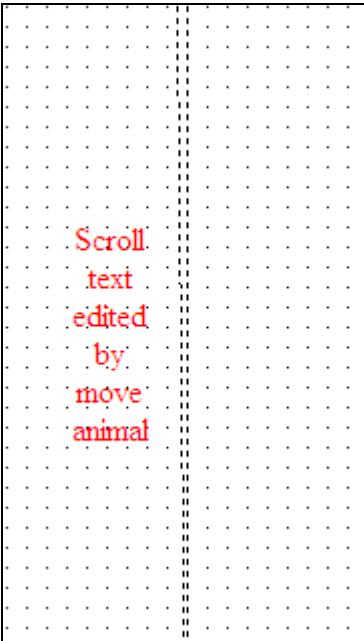

Move Animal

Double-click 'move-animal' and set 'escape time' with 10 second:

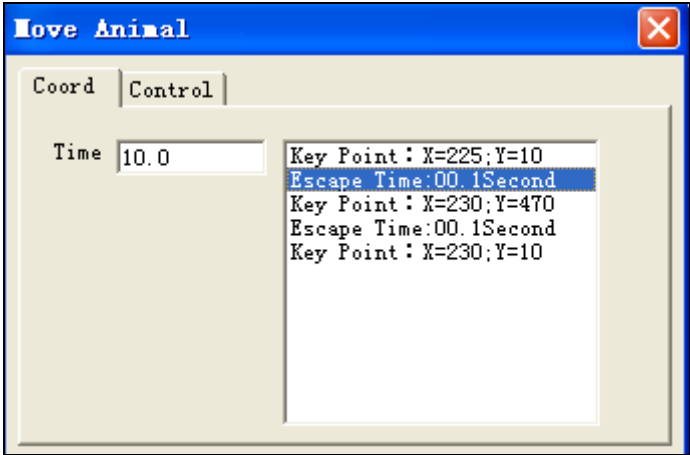

Set property 'control' and select 'Enable control', and 'Reset control' with object PSB300 and PSB 301, is showed as below:

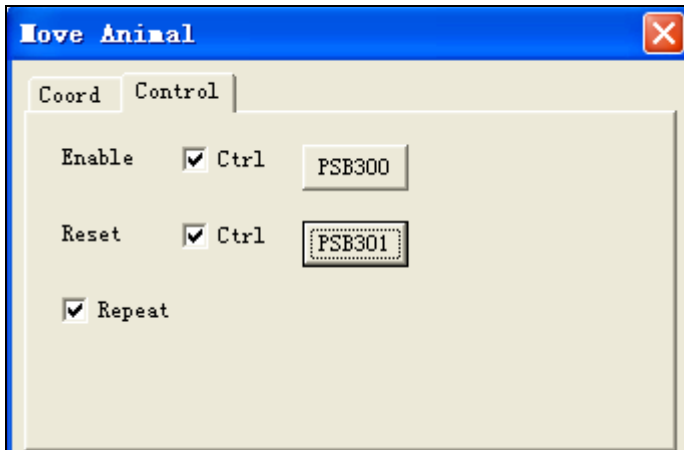

Step4: finish 'move animal'

Select component 'move animal' and 'text', and right click to get a group, as below:

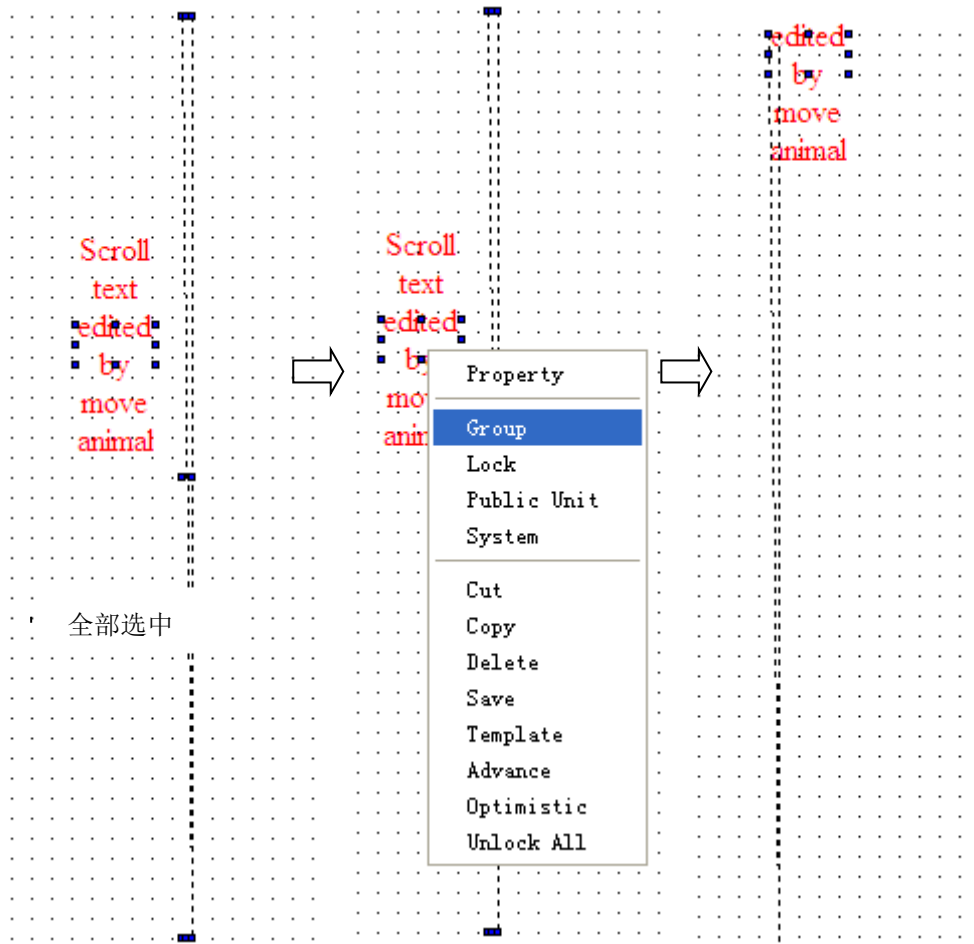

After all above componnet is finished,investigate the running status via emulator offline

14.3 Description of parameter setting

Property of 'Coordinate'

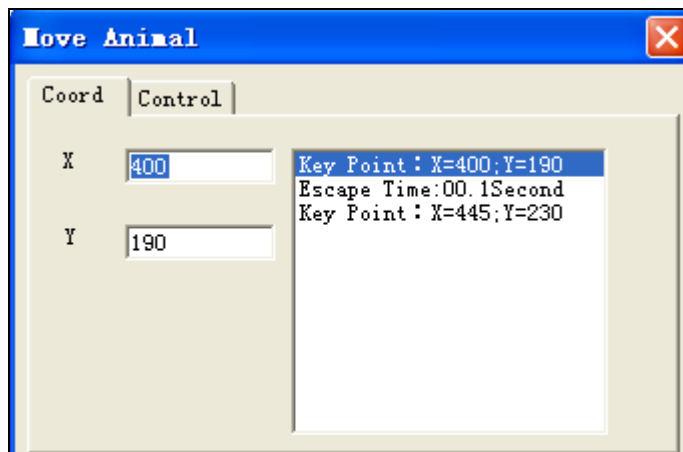

Parameter	Description
Key point	X means abscissa Y means ordinate
Escape time	time spend to move from current point to next point

Property of 'control'

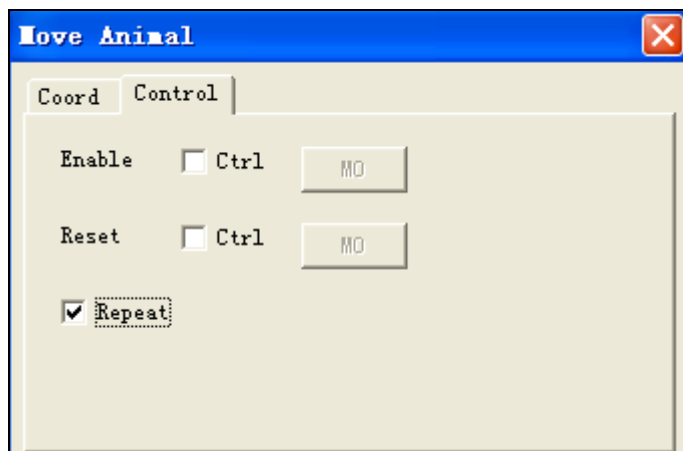

Parameter	Description
Enable signal	Move action is triggered by rising edge of object signal.
Reset signal	'move animal 'is set to return to the beginning point
Repeat	move as the track path in circle if this item is selected,if not ,will not repaet movement.

15 Rotate animal



15.1 Introduction

Similar to component 'move animal' described in previous chapter, this component 'rotate animal' supports animation grouped with component **SWITCH**.

15.2 Procedure

15.2.1 Introduction of simple animation

Step1: Create a new project

Click component 'switch'  (one), 'rotate animal'  (one) and 'rectangle'  (one) and leave them to suitable position, as below:

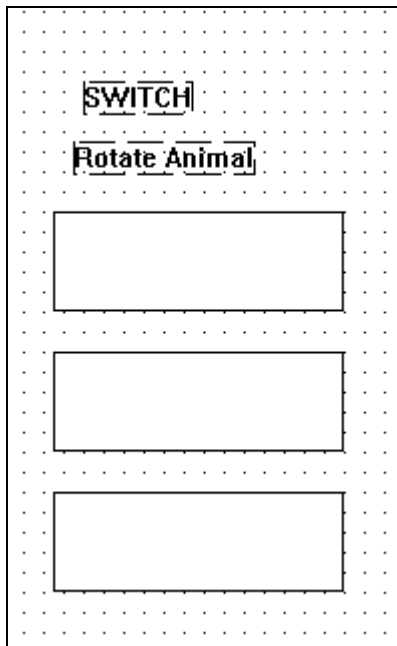

Step2: set property of 'rotate animal'

Double-click 'rotate animal' to set property as below:

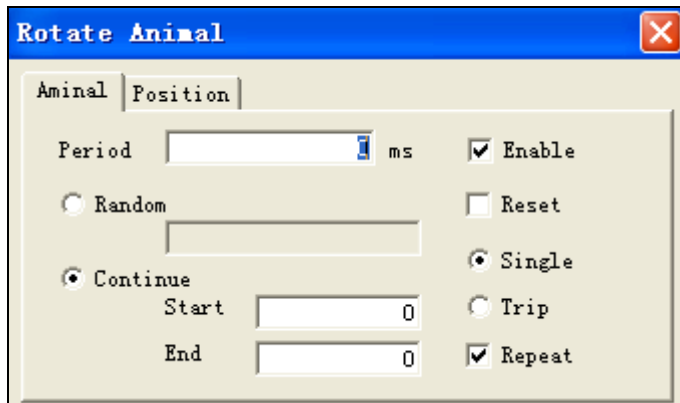

Period: time spent to finish one cycle animation.

Enable Make sure this item is selected during edit process, otherwise, it runs unusual.

Reset This item is not selected in most situation, when use ,please macth with advanced function component.

Continue: the No. of graphs starting from '0'. For eaxample:when NO shows '0',the first graph displays;when NO shows 2,the second graph display, shows graph in sequenenc as this rule.

Continue-start: the first graph when animation begins;

Continue-End: the last graph when animation ends.

Random: differenced with 'continue',graphs don't display in sequence but follow the user defined order; for example:when select 'reset' and enter value '0,2,1', the fact graph order is the first graph, the third graph and the second graph, is showed as below:

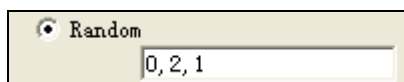

Single: display graphs from first to last ,then from first to last again,running in this rule.

Trip: display graphs from first to last ,then from last to first ,running in this rule.

Repeat: display graphs in circle or not

Set property as below:

Period :1500ms ,e.g 1.5second; select 'comtinue', set end with '2',others keep in default value, is showed as below:

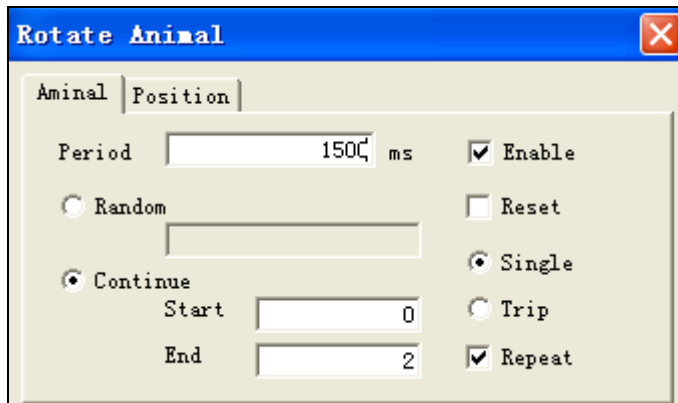

All setting is finished.

Step3: Animation editing

Select 'SWITCH' componnet , 'rotate animal', 'rectangle' and right-click to set property as below:

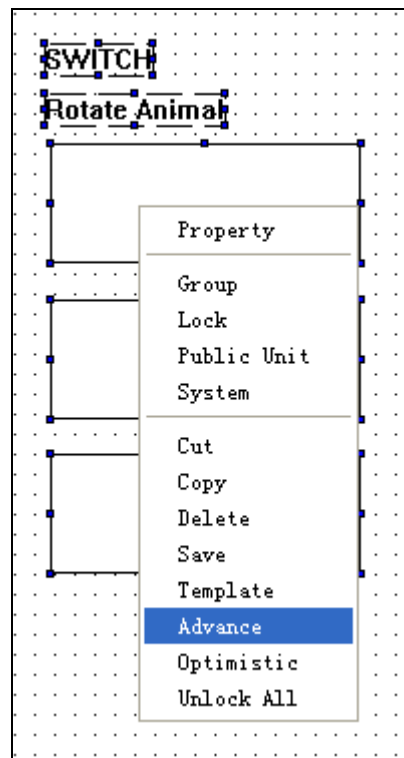

Select 'advance',and is showed as below:

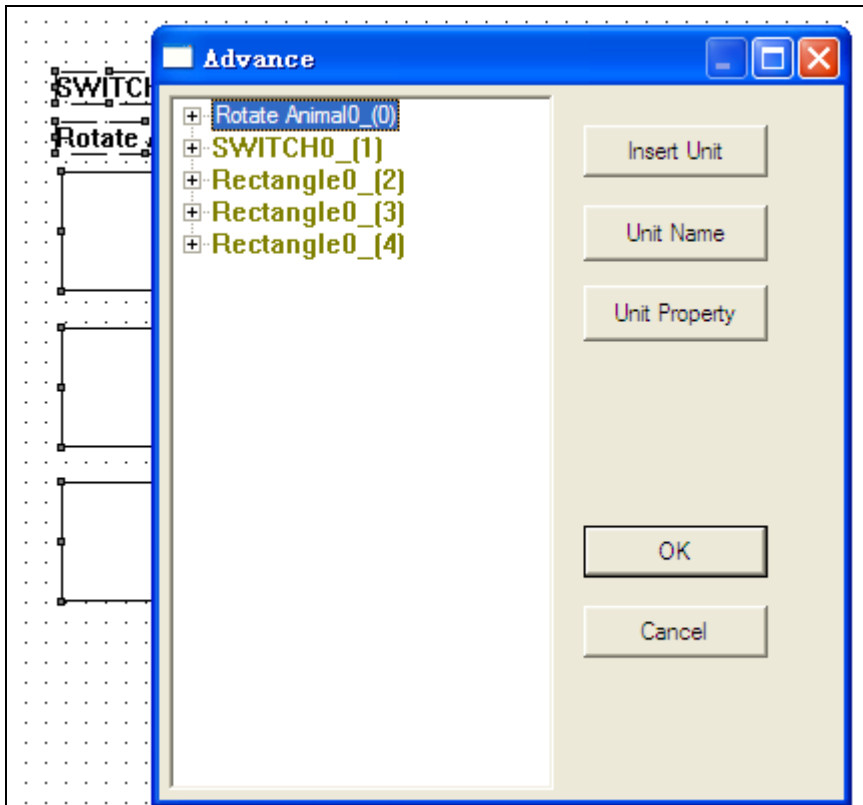

Click 'self property' of Switch and select 'current index'.

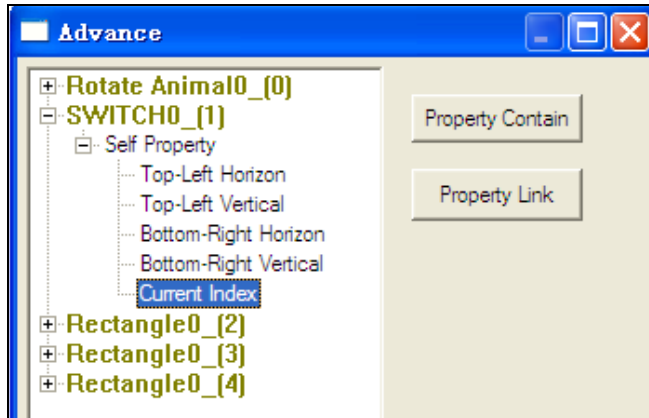

Left-click the right button 'property contain' , then this button convert to gray color

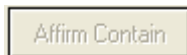

which means this button is not available at present, is showed as below:

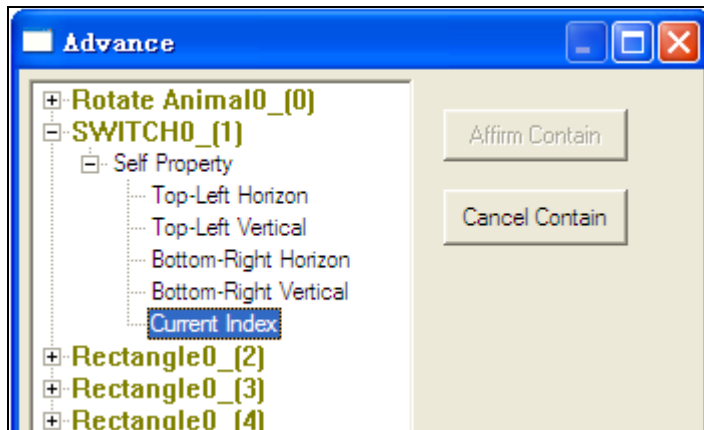

Then click 'Rotate animal' **Rotate Animal0_(0)**, changing happened in the right button, is showed as below:

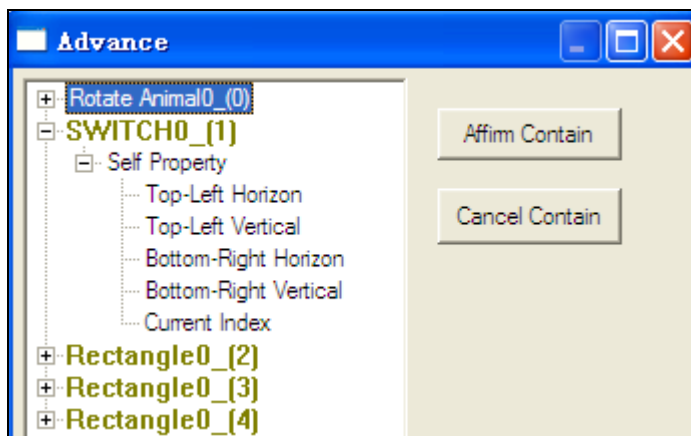

Click 'rectangle' **Rectangle0_(2)**, then button 'Insert Unit' appears, is showed as below:

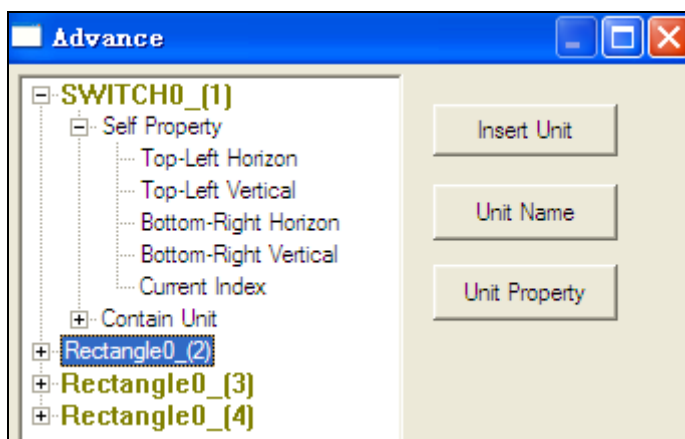

Click 'Insert unit' **Insert Unit**, then button changes to 'Affirm insert' with gray color.

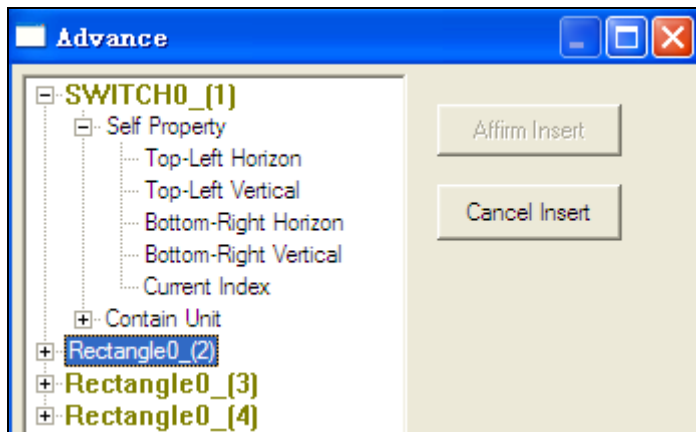

Click “SWITCH” , then button is available.

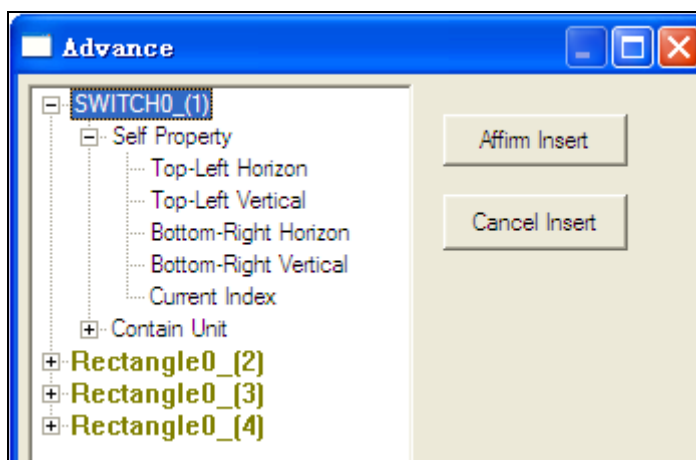

Click ‘Affirm insert’ to finish one insert operation, is showed as below:

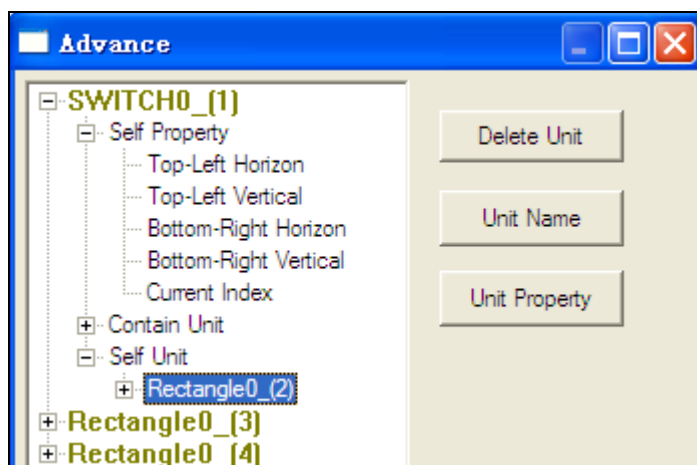

The operation with and is same as the first one, please follow the above steps.

After all above component is finished, is showed as below:

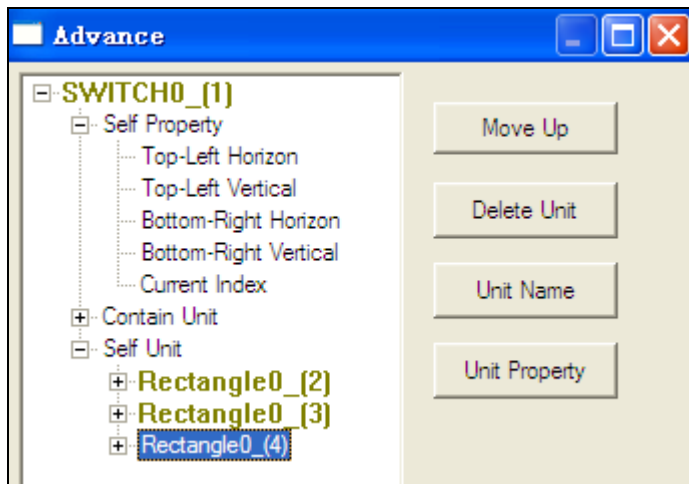

More details regarding advance function please refer to

15.2.2 Example- butterfly

Animation of butterfly contains 'rotate animal', 'move animal', 'advance reference', 'picture', the procedure is showed as below:

Step1: creat a new project :

Click component SWITCH , rotate animal , two pictures of butterfly, is showed as below:

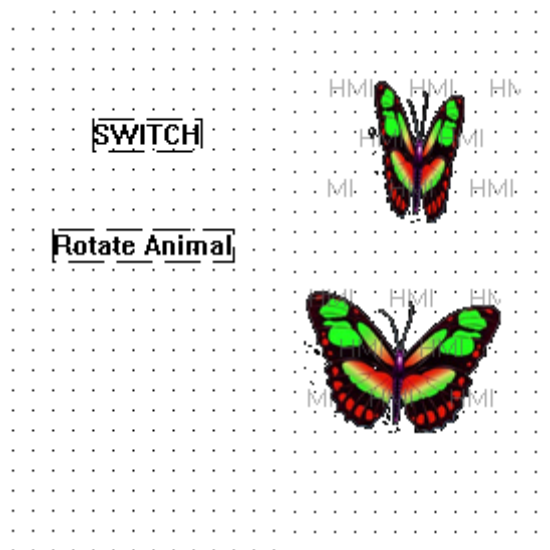

Note; there are two ways to add the butterfly picture into panel:

Way 1:click component 'map'  from toolbar.

Way 2: add picture to 'material library'  then select the destination picture.

Step2: set property of 'rotate animal'.

Set period with time 1000ms, set the continue-end with value 1,as below:

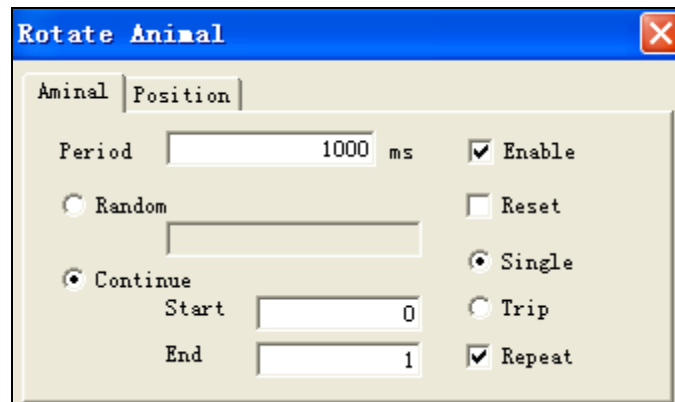

Step3: Flutter of butterfly

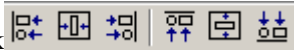
Select the above two pictures ,then click  to edit them as below:



Note : tool 'Align' is available in the case of at least two pictures are selected, otherwise, it shows with gray color.

Select component 'switch', 'rotate animal' pictures and right-click to choose 'advance', as below:

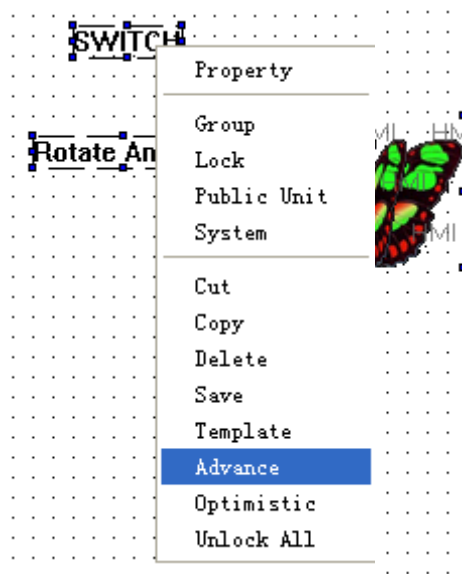

Set property as below: open 'self property' of **SWITCH0_1**, select **Current Index**, then press

button **Property Contain** in the right, click **Rotate Animal0_0** then press

button **Affirm Contain**, is showed as below:

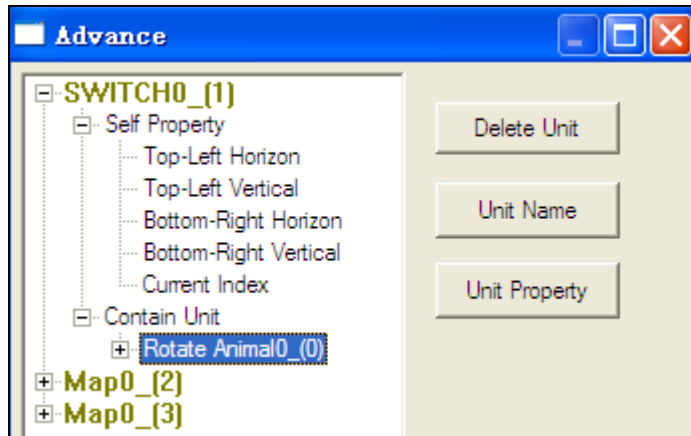

Select **Map0_2** and press button **Insert Unit**, then click **SWITCH0_1**, press

button **Affirm Insert**, the result is showed as below:

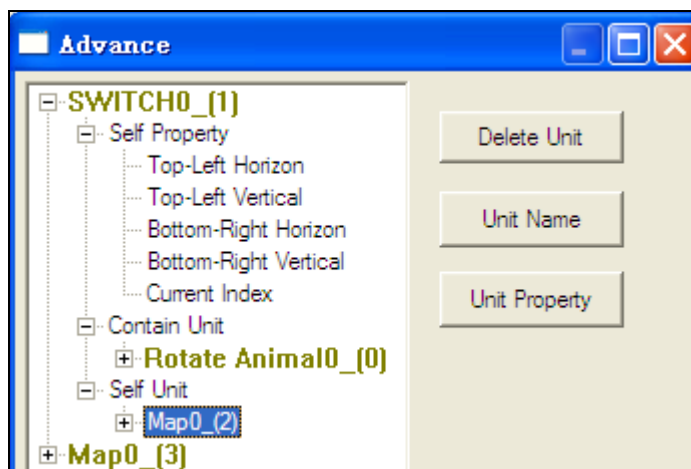

Do the same operation on Map 3 as Map2, then is showed as below:

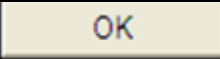
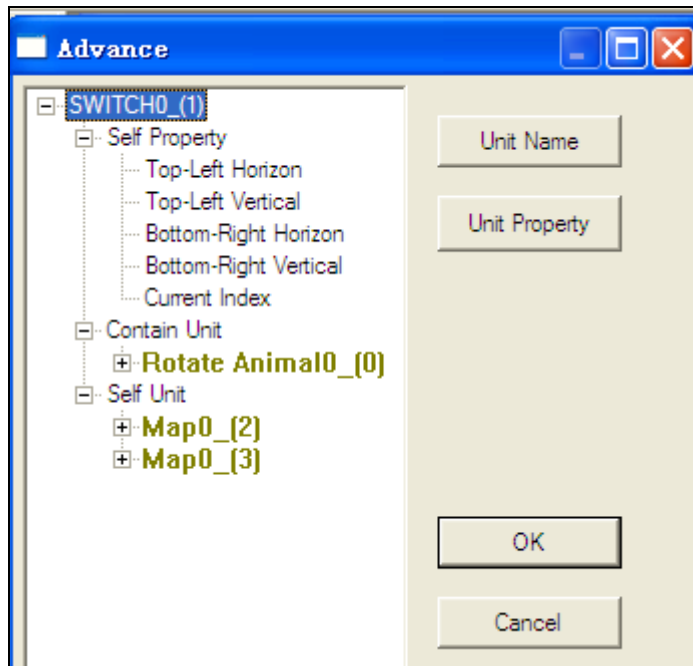

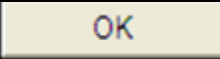
After all above editing, then press button , investigate the flutter via emulator offline.

Step4: Edit on butterfly motion

Click component 'move animal' , then make a track as below:

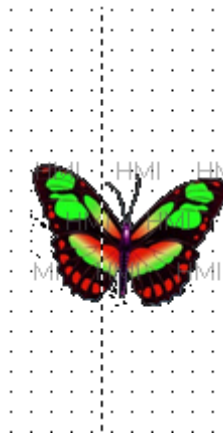

Double-click to set property with 'escape time' 10second, others is kept in default value:

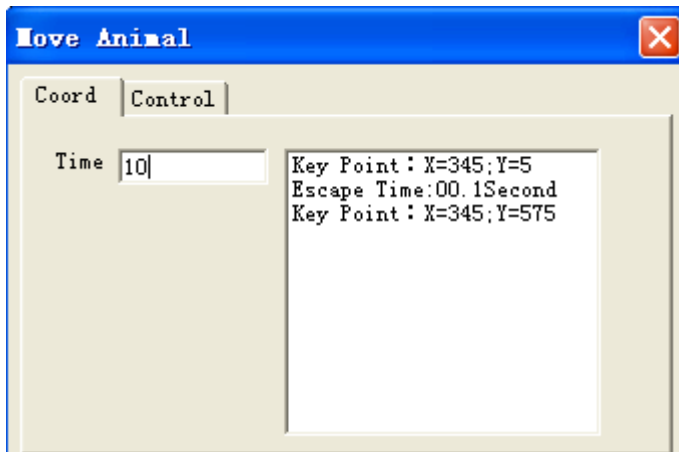

Select 'move animal' and 'butterfly', and right-click to group, as below:

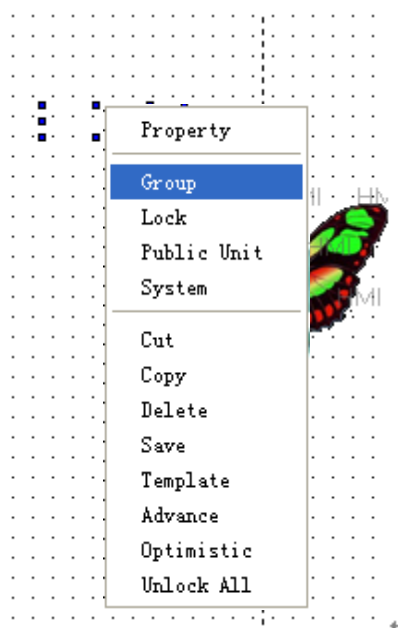

All steps are finished, investigate the running via emulator offline.

15.3 Description of parameter setting

‘Rotate animal’-Property of ‘animal’

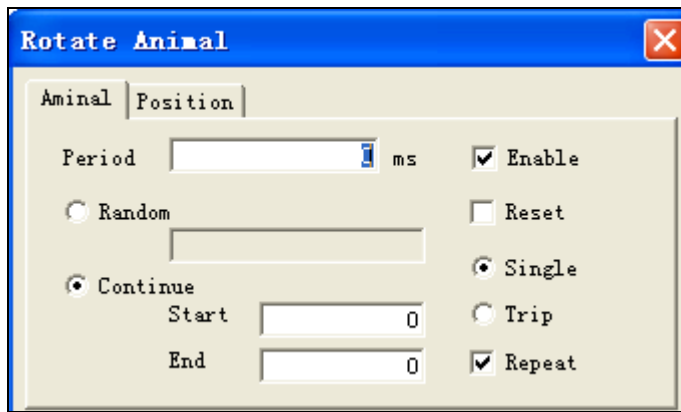

Parameter	Description
Period	time spent to finish one cycle for all object animation
Continue	the No. of graphs starting from '0'. For example: when NO shows '0', the first graph displays; when NO shows 2, the second graph displays, showing graphs in sequence as this rule. Continue-start: the first graph when animation begins; Continue-End: the last graph when animation ends.
Random	differenced with 'continue', graphs don't display in sequence but follow the user defined order; for example: when select 'reset' and enter value '0,2,1', the fact graph order is the first graph, the third graph and the second graph,
Enable	Make sure this item is selected during edit process, otherwise, it runs unusual.
Reset	This item is not selected in most situation, when use ,please mach with advanced function component.
Single	display graphs from first to last ,then from first to last again, running in this rule.
Trip	display graphs from first to last ,then from last to first ,running in this rule.
Repeat:	display graphs in circle or not

16 Recipe

16.1 Introduction

- What is recipe?

Recipe: a string of parameters generated for production.

- Why do we need recipe ?

With development of industry, it is obviously that ways to enter parameters by manual for workpiece leads to low efficiency. But touchpanel as interface between operators and machine, save a string of parameters and get ready to be invoked whenever there needs.

- Recipe edited in panel

There are two kinds of registers built in panels, PSW and PFW:

PSW: Word object need power

PFW: Word object which can maintenance without power

we use PFW registers during the application of recipe.

Concept : recipes are saved in a string of continues registers, with index saved in PSW40 to select the needful ones, as shown below:

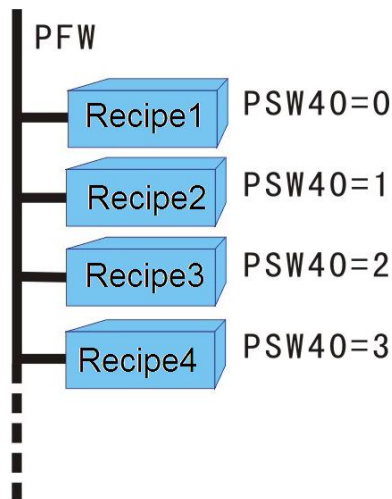

Note: PSW40 is available only edit tool in advance mode ,more details regarding how to enter into advance mode please refer to <HMI manual Basic>

16.2 Example

This chapter take the following example to describes how to generate Recipe.

Background: groups of workpiece with different size,material and quantity.

Method : all parameter informations are saved into continues registers, which means one group parameters stand for one recipe. It is only to transmit destination recipe data from panel to PLC when there needs.

16.2.1 Write recipe datas to PFW registers.

Note : this Step is not needed if there is not too many datas ,input datas with panel operation instead.

1. the aim of this step is to record all datas in PFW registers,please as following steps:

Open the edit tool- Touchwin,click 'file',and select 'PFW SET'. Is showed as below:

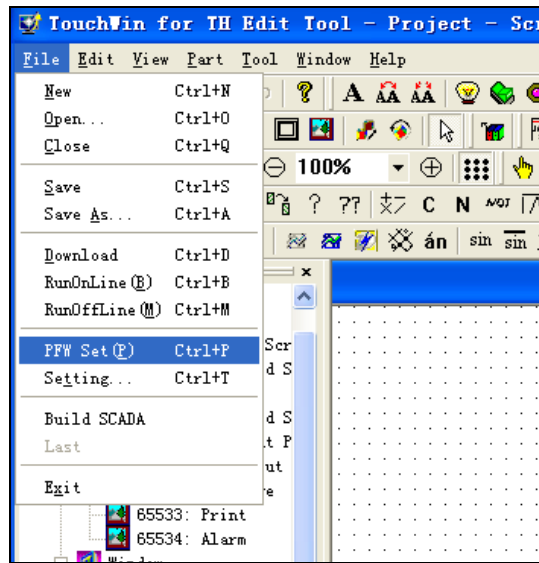

2. Define the first address PFW[***] and the last address PFW[***], then press button , then the datas PFW[***]-PFW[***] will appear.

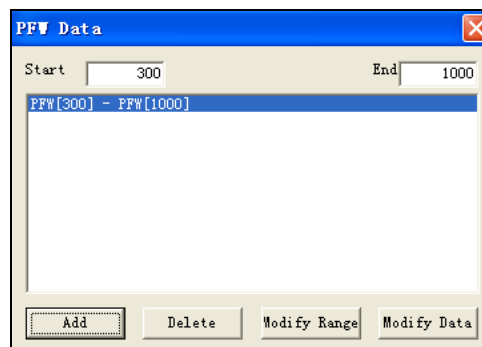

3. Double-click FW[300]-PFW[1000], then edit PFW datas

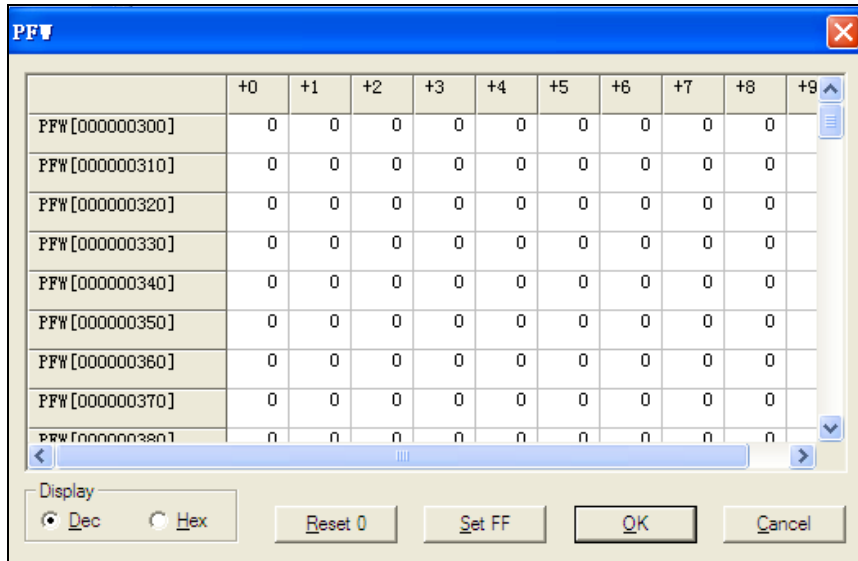

4. Input right datas in right registers, press  to exit.

Make sure the input datas in the sequence as the parameters of the workpiece, for example, the data is arranged as below:

Type	Length	Width	Thickness
A type	136	253	120
B type	269	200	216
C type	156	172	236
D type	252	137	254

Thus, the data need to enter into the first line of the list is: 136, 253, 120, 269, 200, 216, 156, 172, 236, 252, 137, 254. After this, only to download datas from PC to panels, the value of registers are assigned in this sequence.

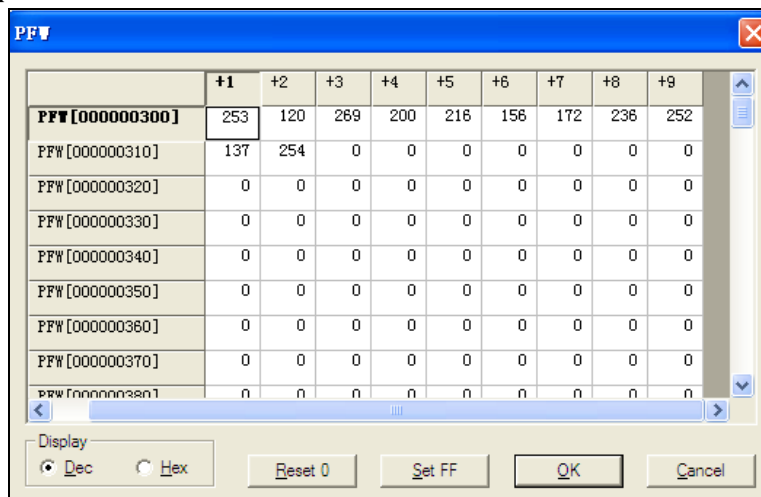

16.2.2 Download Recipe

1. How to invoke and manage these datas? Recipe index PSW40 can solve this problem well, with reference between PSW40 and button 'down recipe' , ensure the whole process runs perfectly.

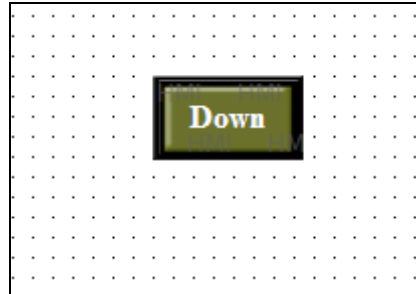

2. As destination data, these datas are built in PLC. Like the following picture, D0 as the first address of the device data, with three registers for each group, so the PLC runs based on the value of D0, D1 and D2. As device data, with first address PFW300 and occupy 3 registers, so the arrangement is PFW300, PFW301 and PFW302.

3. Set the property of 'object' and 'recipe', is shown as below:

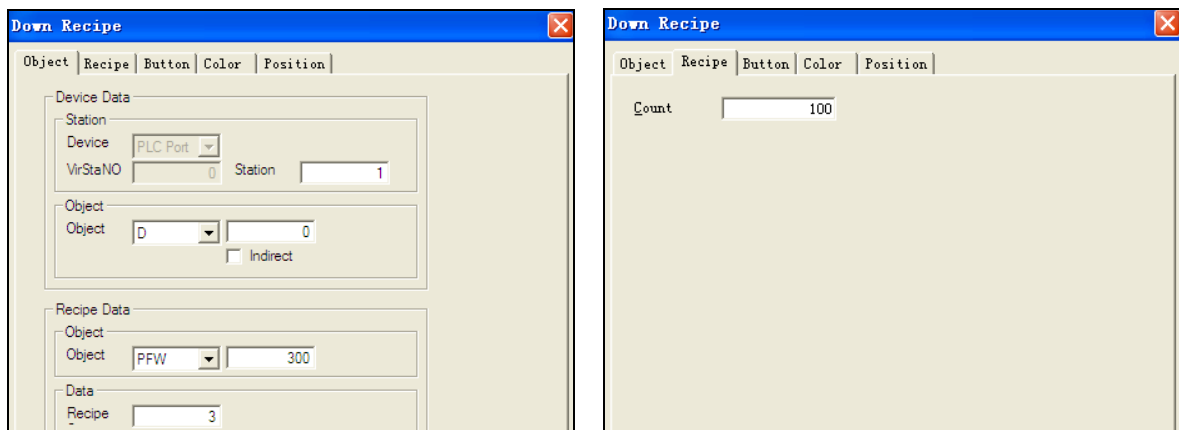

4. After all above setting, the edit on 'down recipe' button is finished, we defined the address of the first group both in PLC and panels, it seems like there is no way to connect PSW40 and these datas together, but in fact, PSW40 as a bridge to connect the button 'down recipe' and these datas set in panels.

It runs in the following rule:

When PSW40=0, press button 'down recipe', the datas from PFW300 to PFW302 is transmitted to the register (D0~D2), which is for workpiece A.

When PSW40=1, press button 'down recipe', the datas from PFW303 to PFW305 is transmitted to the register (D0~D2), which is for workpiece B.

So we only need to modify value of PSW40 to get reference with corresponding recipe datas.

Note: It is necessary to use index PSW40 when it is matched with button 'down recipe' and button 'up recipe'. Regarding the procedure to support recipe function with other register as index, please refer to the

following chapters..

16.2.3 Modify and display the recipe data

1. We change the group by modifying indexPSW40. there are three components 'digital input' in the screen to investigate the data.

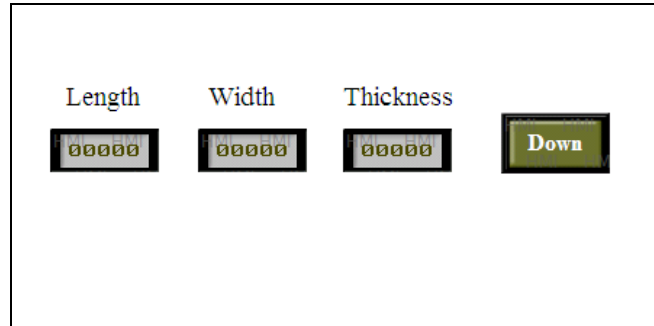

2. Set the first register standing for 'Length' with object PFW300, is showed as below

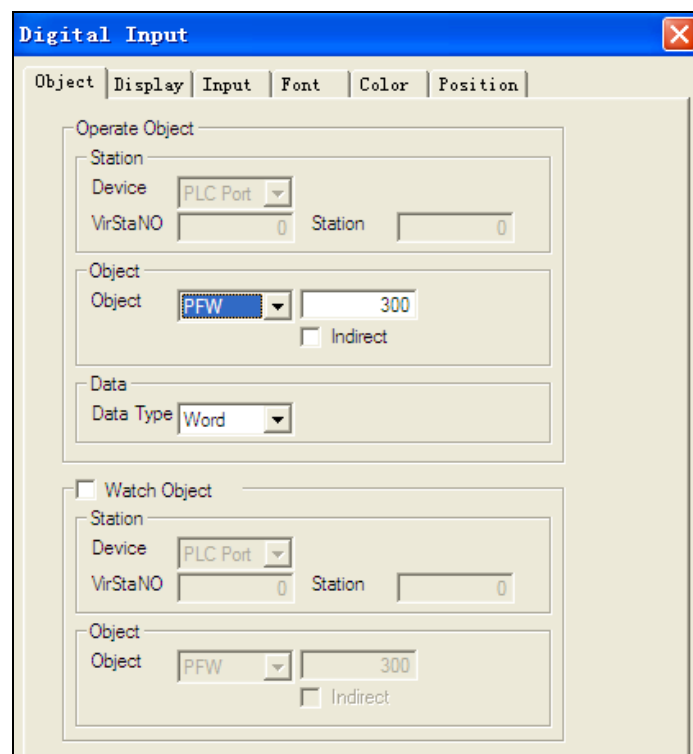

3. As we know, the PFW300 is the first address of all recipe data, how to display all parameters by these three registers? So we set the registers with indirect mode to get reference with index PSW40, as shown below:

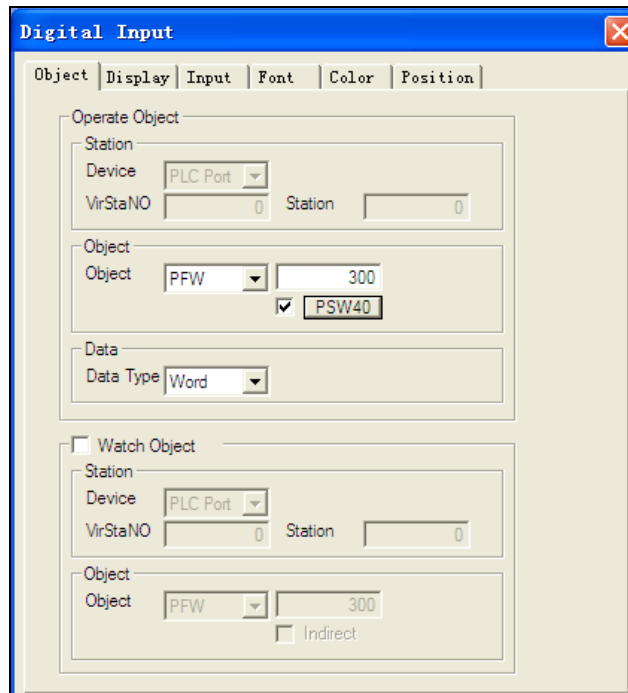

4. Select 'indirect' Indirect, and double-click to modify the object with PSW40, is showed as below:

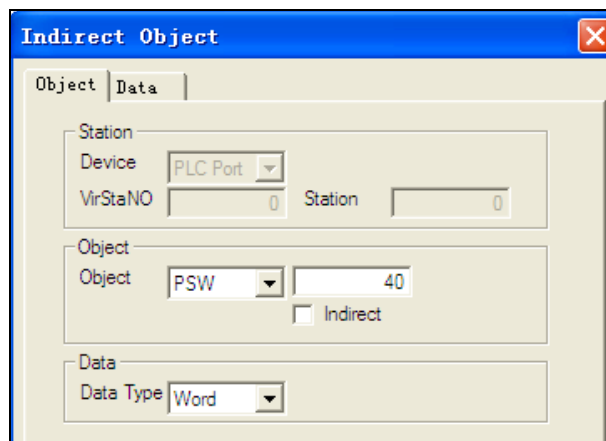



5. Set property 'data' of 'indirect object'. As said above, each group contains three data, so the times is set with 3, click OK to affirm.

Thus, the setting on parameter 'length' is finished.

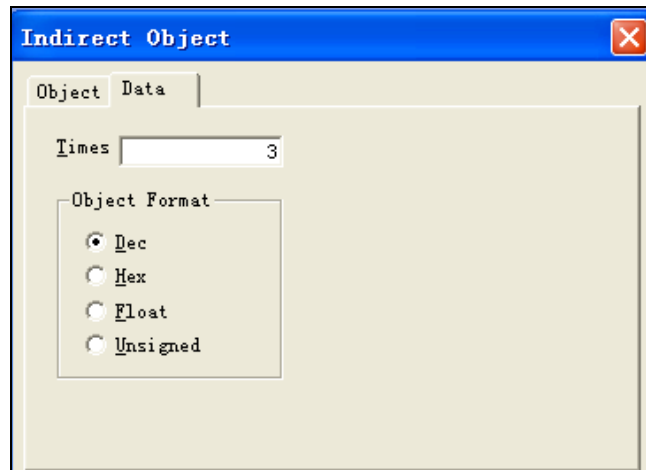
Please set the parameter 'width, thickness' as the same way as setting on parameter 'length'.



16.2.4 Display name of the recipe

1. In order to distinguish each group easily, we take a name for them. Click component  to enter group name, as below: 



2. Double-click this component to set property.

The parameters of recipe occupy registers is $3 \times 100 = 300$, from PFW300 to PFW599. So we take the register PFW800 as the first address of the group name, every two characters takes up one register, so like 'A TYPE' occupies 3 registers, so is showed as below:

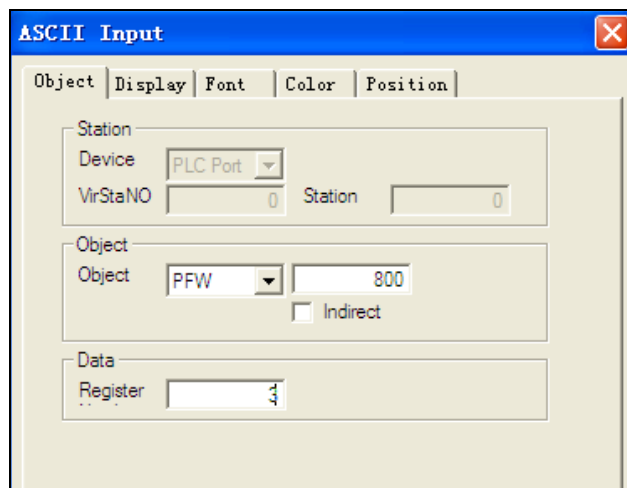

3. Select 'indirect' mode and double click to set object with PSW40

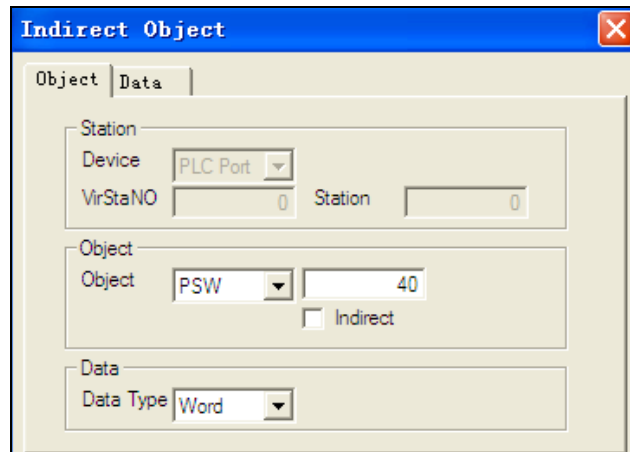

4. Set property 'data' of 'indirect object'. As said above, each group name takes up 3 registers, so the times is set with 3, click OK to affirm.

Thus, the setting on parameter name is finished

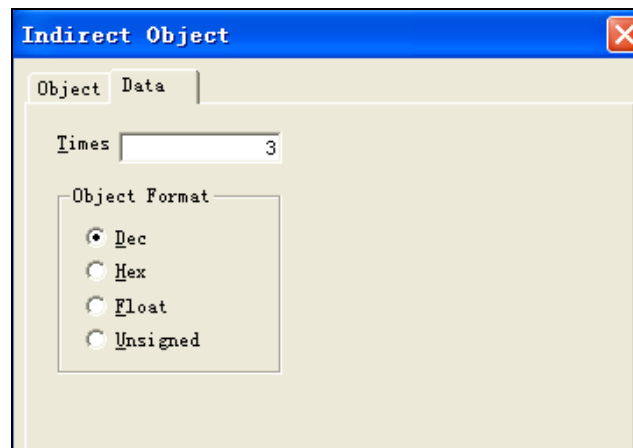

16.2.5 Switch button for Index

How can we change the value of the index (PSW40)? There are two ways: first: with component 'Digital input' to enter data directly. Second: increase or reduce the index by 'up' and 'down' key.

This chapter will take the second way as an example to describe how to change the value of index.

The procedure is shown as below:

1. We edit the increase button first, e.g. the 'up' button. click component 'set data' , as below:

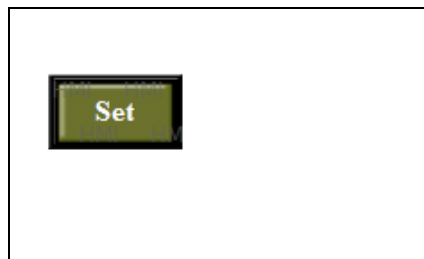

2. Double-click to set property, object with PSW40;

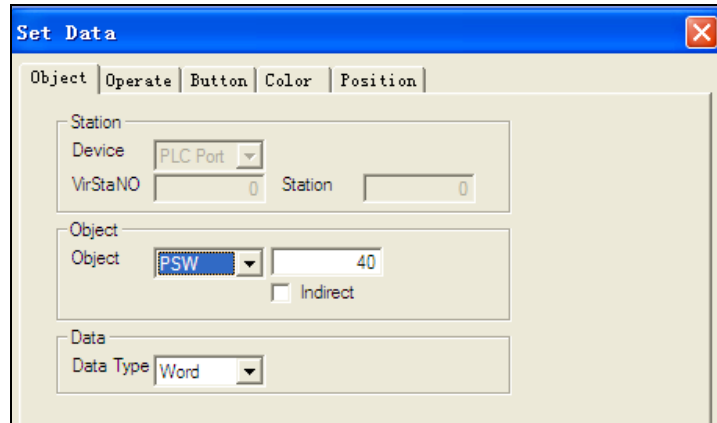

3. set the property 'operate' with operand with 1 is showed as below:

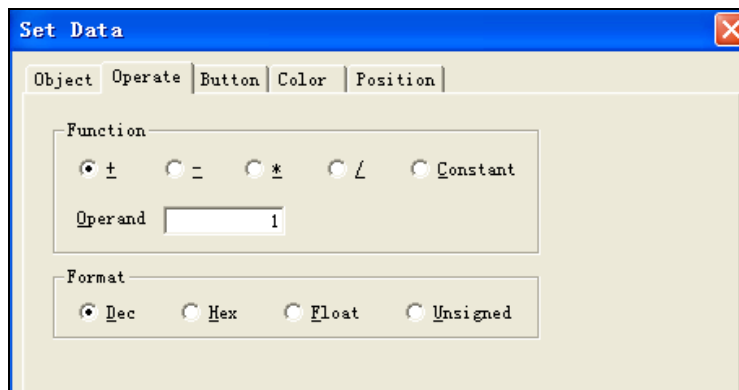

4. Change the view of the button, is showed as below, at the same time ,set the down button with the right view,

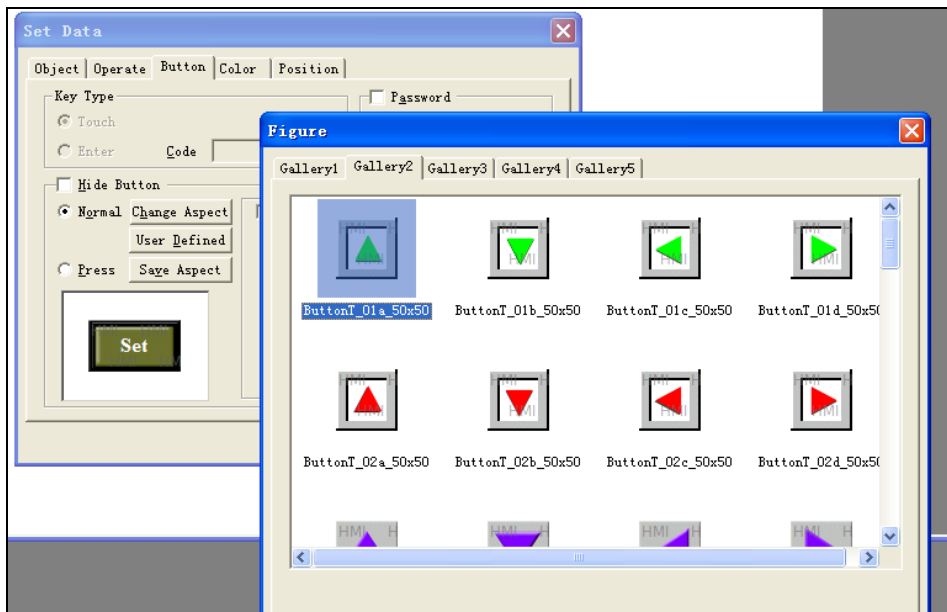

5. Download the project to the panel, is showed as below

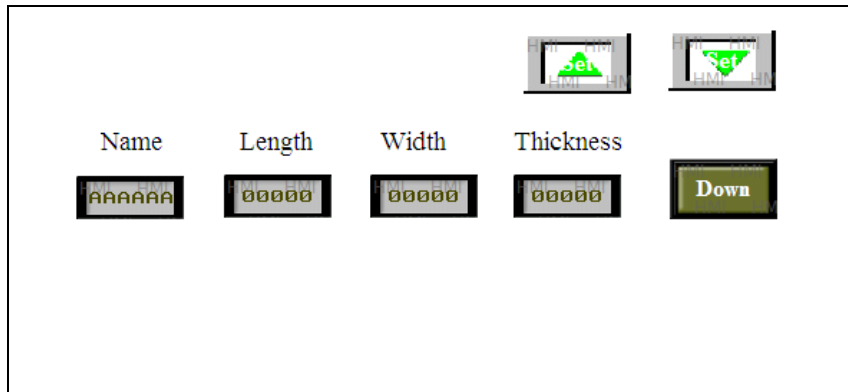

16.2.6 UPload recipe

Recipe function can not only support downloading data from panel to PLC, but also support uploading data from PLC to panel when there is a need.

This chapter takes the example to describe how to use this function. Based on the above example, operators modify the parameters of workpiece in the PLC when there is a new type to work on. So what we need is to upload the data from PLC to panels and save these data for next invocation.

1. Based on the above example, click component 'up recipe'  as below:

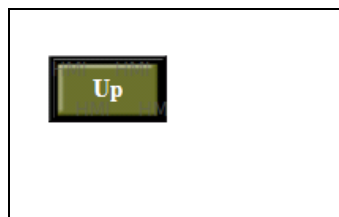

2. Set property like this: device data with object D0, recipe data with object PFW300, 'RECIPE' with 3, as below:

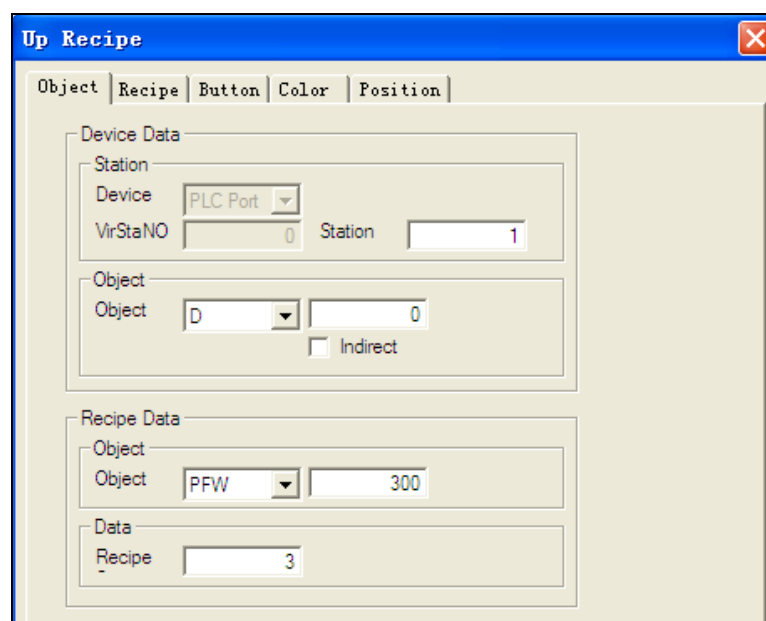

3. Set the property of 'recipe' with 100, as below:

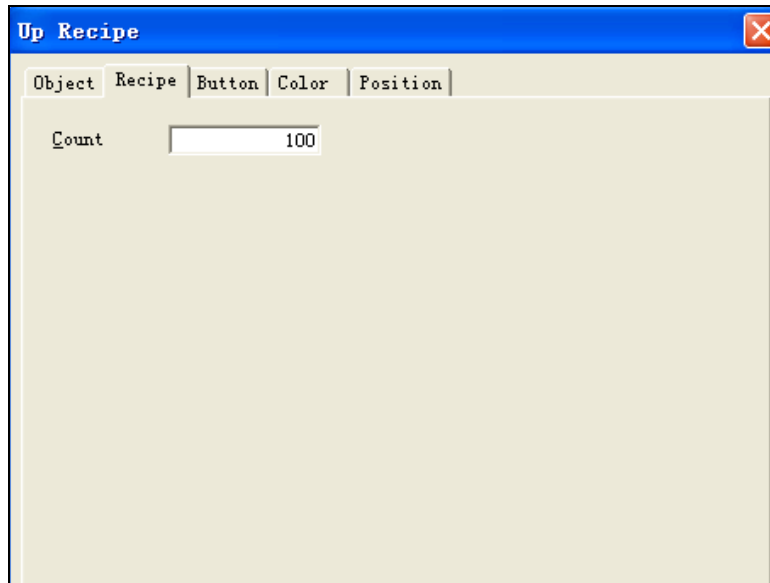

4. After all above steps is finished ,the project is showed as below:

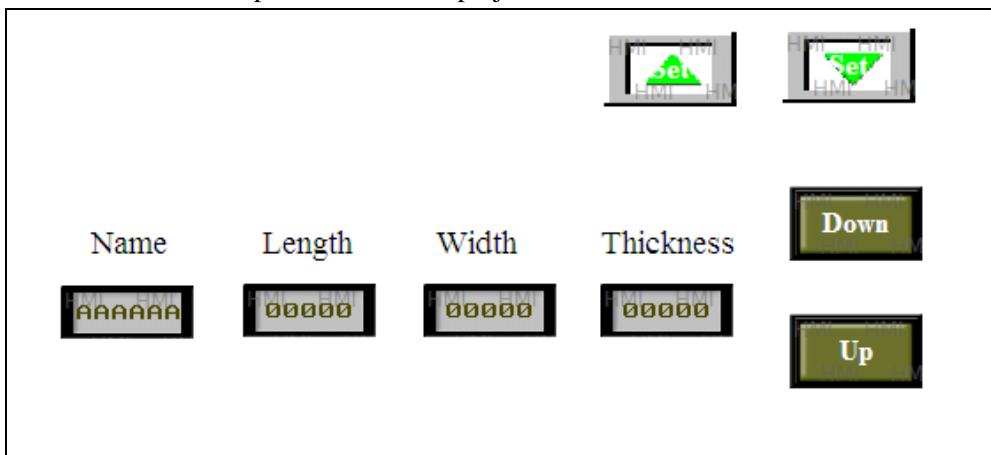

5. According to value in INDEX PSW40, the destination data in PLC is uploaded to corresponding registers by pressing button 'UP'.For example, when PSW40=10 with the beginning address in panel is PFW300,after pressing button'UP', the data from D0 to D2 is transmitted to register PFW330, PFW331, PFW332 .

17 Export sample data

In the most cases, the display and inuput of sample datas based on component'data grid'and 'grid control'can not satisfy requirements in data analysis,but componnet 'export sample data'comprising of 'data sample' and 'export data' has perfect performance in this aspect and brings advantage to holding control process for users.

17.1 Procedure

1、 Click component 'export sample data'  from toolbar and leave it as below:

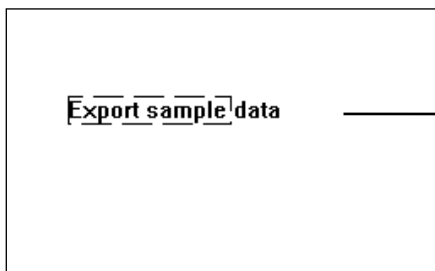

- This component is hidden in running.

2、 Double-click this component to set property, including 'Common,sample,destination,save,export control,data time,position'seven items,is showed as below:

(1) Property of 'Common'

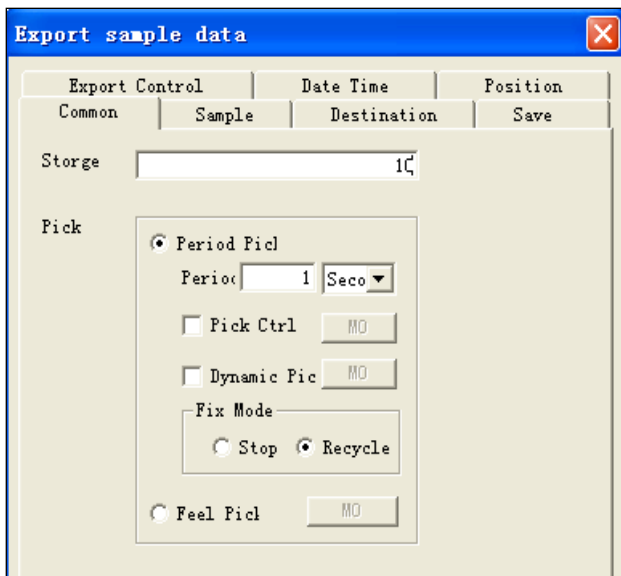

- Storage size: amount of input datas
- Pick mode:
contain 'pick period' and 'pick feel'.
 - Pick period:
sample data at fixed intervals.
 - Pick feel:
sample action is triggered by rising edge of signal.collect data once at each rising edge

The parameter setting in period mode is showed as below:

Period: set period value and unit. The min.period is 1 s,e.g collect a data every second.

Pick control:start to sample when referenced coil is triggered. Data collection stops when coil status

convert from ON to OFF.

Dynamic mode and fix mode

Dynamic Mode:

The 'fix mode' is in 'stop' mode when 'variable mode' is selected with referenced coil OFF.

The 'fix mode' is in 'circle' mode when 'variable mode' is selected with reference coil ON.

While 'variable mode' is not selected, 'stop' and 'circle' can be selected by user.

Fix Mode:

Fix mode-stop: sampled datas are saved to destinationed registers in sequence. When it has its full complement, the new sampled data instead of the old data from the beginning address until new full complement coming, cycles in this rule.

Fix mode-circle: sampled datas are saved to destinationed registers in sequence. When it has its full complement, saving process is stopped.

Pick feel: sample action is triggered by rising edge of signal. collect data once at each rising edge .

(2) 'Property' of sample

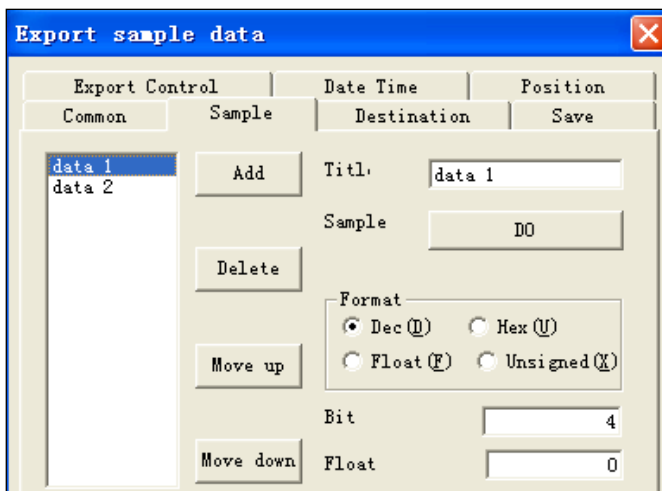

- Title: add new line by button

, modify name with



- Sample: set sample object with selecting

right title line

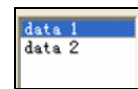

- Format: select the right format.

(3) Property of 'destination'

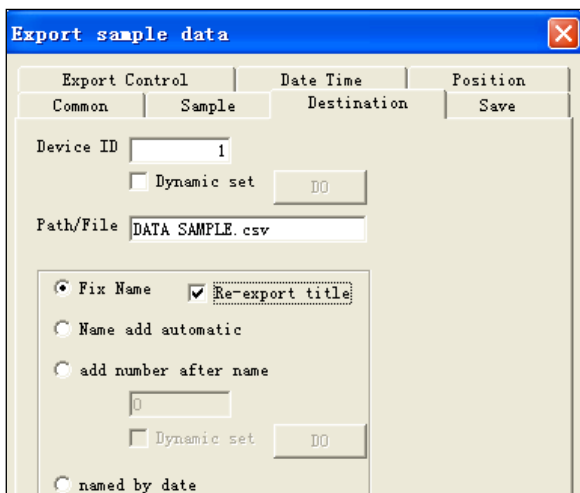

- Device ID: the ID of U.disk when there are more than one disk. ID can be set by manual or

dynamic register

- Path/File: name of import CSV file.
- Fix name: only file name in 'path/file' is active.
- Re-export title: export data with title information every time.

- Name add automatic: file name is comprised of name and ID, ID value add 1 automatically by every export operation.(range of ID:000~999),is showed as below:



- Add number after name: add ID after file name by manual ,or according to the value of dynamic register.
- Named by date:take the current date and time information as file name,once it is selected ,the filename in 'path/file' will not be active,as below:

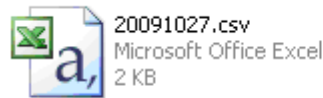

(4) Property of 'save'

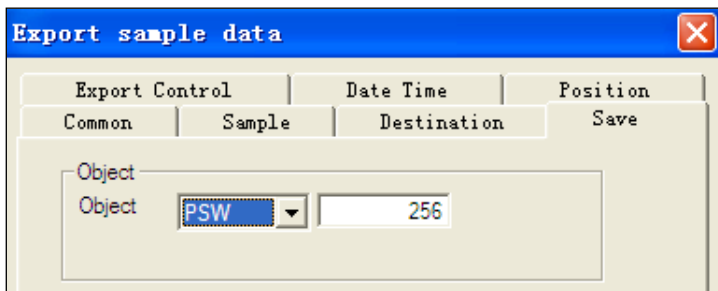

- Object: the first address of register to save data.

(5) Property of 'Export control'

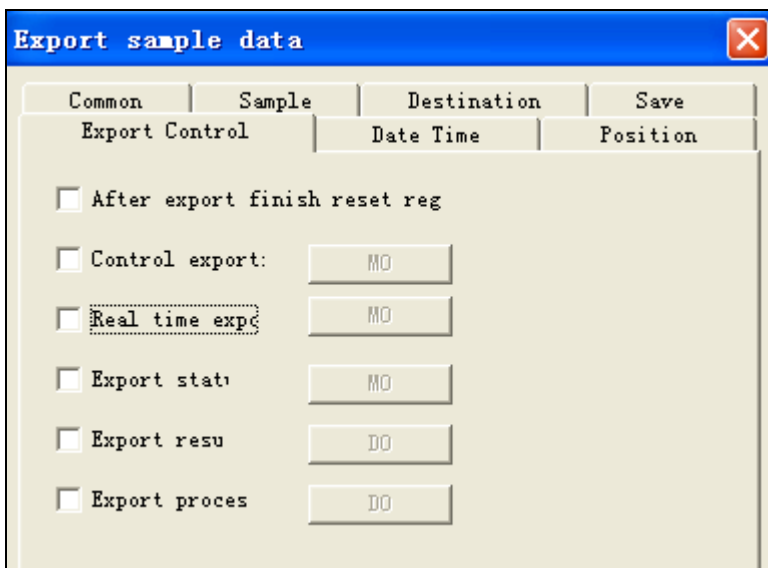

- After export finish reset reg: reset registers which is used for data save once data export is finished
- Control export: export action is available when the referenced coil is ON.
- Real time Export: data is export when the referenced coil is at rising edge.
 - Execute status: indicate import status by coil. When coil is on it means it is in export process.
 - Excute result: show the result according to value of referenced register.

Meaning based on different value is showed as below:

1. Name of path file is incorrect.
 2. Read/write file is failed.
 3. Export successfully.
 4. Device for export doesn't exist.
 5. Memory is not enough
- Execute process: show the procedure according to value of referenced register.(range of value is from 0~100,and 100 means finishe import)

(6) Property of 'Date Time'

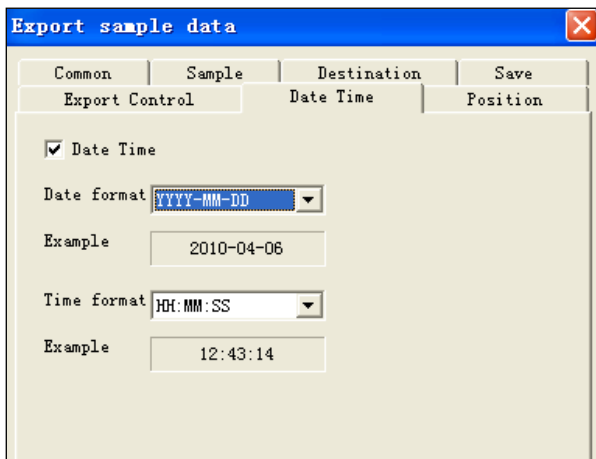

1. Date Time:export data with Date/time information when selected.
2. Date format/Time format:select the format

17.2 Example

This chapter takes sample to describe how to use this component.

The purpose of this example is to save data sampling from register PSW300 and PSW400.

The procedure is showed as below:

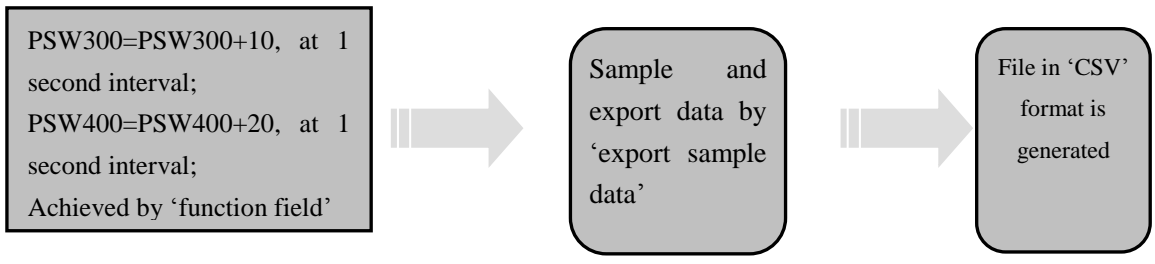

Details is showed as below:

- The data source changes in following way:
 PSW300=0, PSW400=0;
 PSW300=10 ,
 PSW400=20;
 PSW300=20 ,
 PSW400=40;
 PSW300=30 ,
 PSW400=60;
 PSW300=40 ,
 PSW400=80;

The data collected from data source save to registers from PSW500 with time information. The pick action is controlled by coil PSB500 and select dynamic mode control by coil PSB351.

- Export the datas with export controlled by PSB300 and real time controlled by PSB301

- File in 'CSV' format is generated

The following chapter describes the procedure step by step.

1、 Data source

Click component 'function feild'  from toolbar and set property as below:

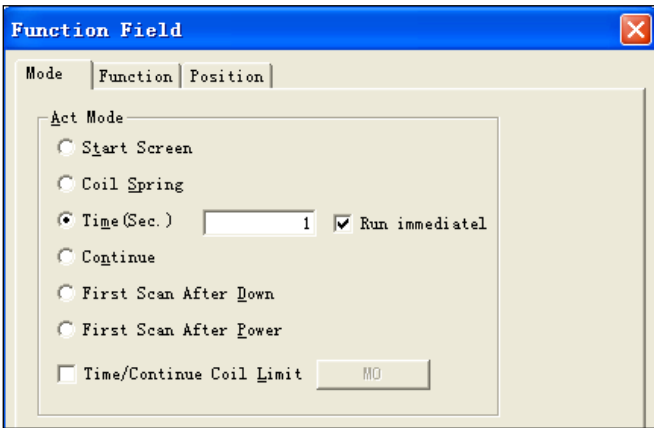

- Act mode :select 'time 'mode at 1 second mode with 'run'immediatel.

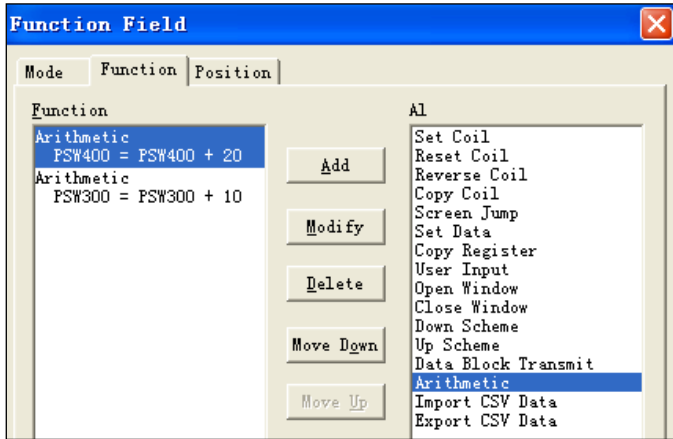

- Add function with 'arithmetic' with below:

PSW300=PSW300+10;
PSW400=PSW400+20;

Click component 'digital display' to display the value of these two registers

2、 Export sample data

Click component  from toolbar and set property as below:

Property of 'common'

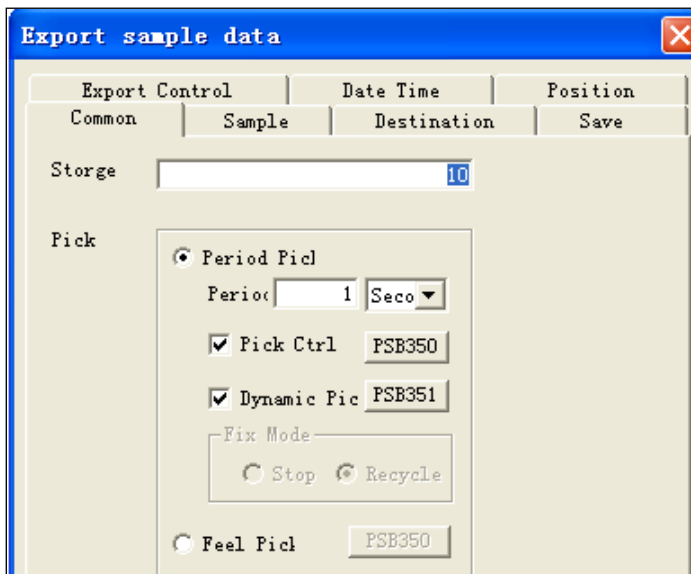

- stroge: 10 groups of data, each group contains 1data from PSW300 and 1 data from PSW400.

- Pick mode: select 'period mode' at 1 second interval.

- Pick control: select coil PSB350, when PSB350 is ON, pick action stars,it stops while coil PSB350 is OFF.

- Dynamic pick: select coil PSB351. When PSB351 is ON, running in cycle,otherwise, in stop mode

Property of 'sample'

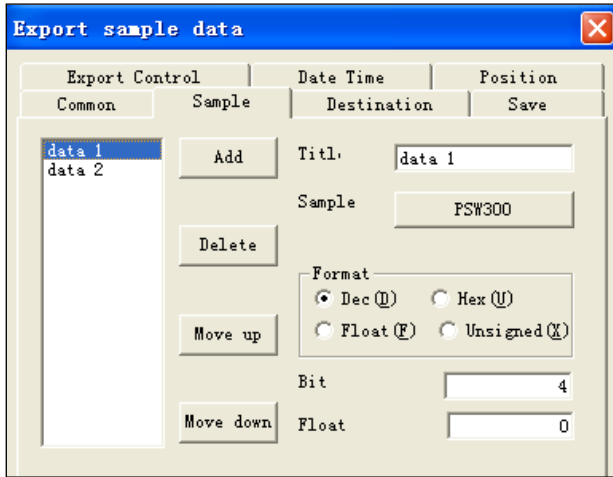

- Add to 2 items by button
- Data1:with object PSW300;
- Data2:with object PSW400;

Property of 'destination'

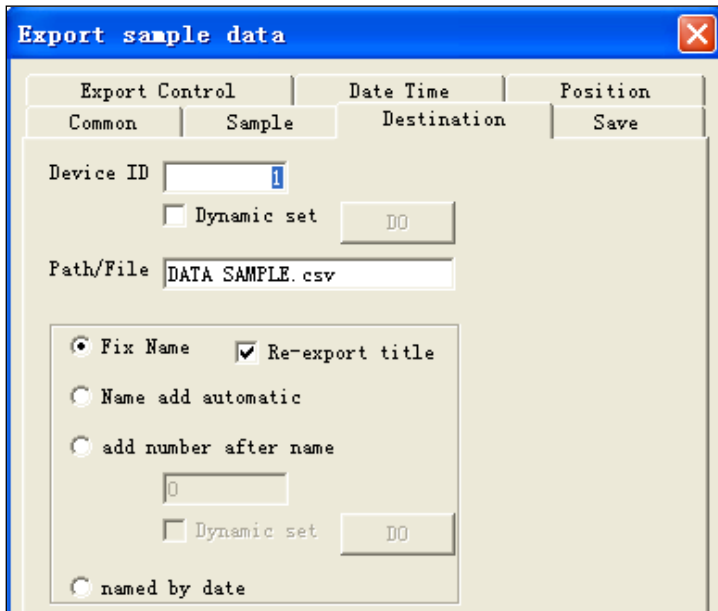

- Device ID: with default value1
- Path/file: with name DATA SAMPLE.csv
- Select 'fix name'and 're-export title'

Property of 'save'

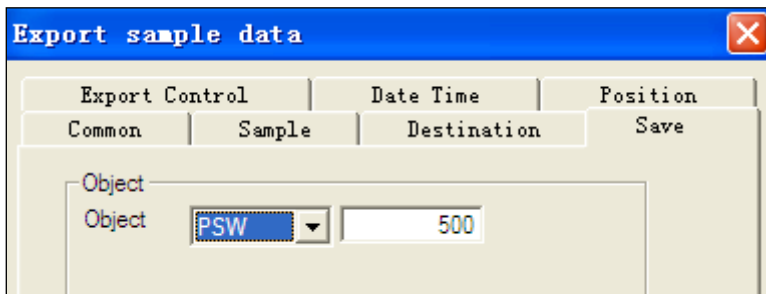

- Save data with boject PSW500.

Property of 'export control'

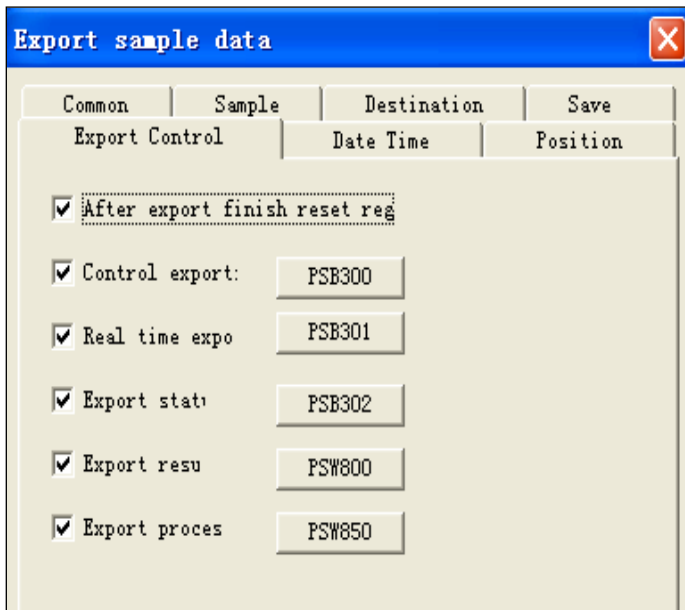

- Select 'after export finish reset register'
- Control export: with PSB300 which means export action is available when PSB300 is ON, otherwise, it is not allowed.
- Real time export: data is exported when this coil PSB301 is ON.
- Export status: when PSB302 is on, it means it is during the export process.
- Export result: the result is in PSW800
- Export process: the status of export, 100 means export successfully.

Property of 'date/time'

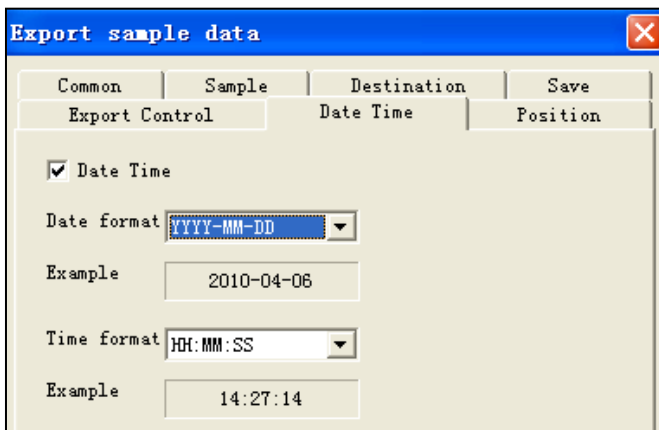

- Date time: Select this item, the time information will be showed in the CSV file.

Thus, all above component is finished.

3、 Edit other components.

All components in this project are showed as below:

Name	Object	Operation	Function
Lamp button	PSB300	Reverse	Export control
Lamp button	PSB301	Instant ON	Real time control
Lamp button	PSB350	Reverse	Pick control
Lamp button	PSB351	Reverse	Dynamic control
Lamp	PSB302	Display only	Export status
Digital display	PSW300	Display only	Data source(add 10 every second)
Digital display	PSW400	Display only	Data source(add 20 every second)
Digital display	PSW800	Display only	Display export result
Digital display	PSW850	Display only	Display export process

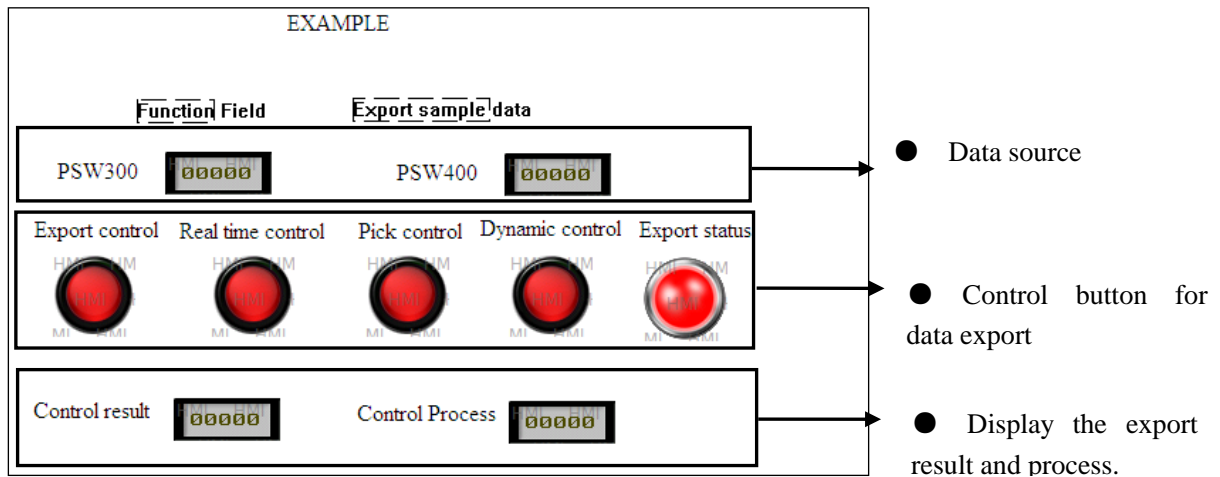

After data export, the data in CSV file is showed as below:

	A	B	C	D	E
1	Data 1	Data 2	Date	Time	
2	750	1500	2009-9-12	11:02:48	
3	760	1520	2009-9-12	11:02:49	
4	770	1540	2009-9-12	11:02:50	
5	780	1560	2009-9-12	11:02:51	
6	790	1580	2009-9-12	11:02:52	
7	800	1600	2009-9-12	11:02:53	
8	810	1620	2009-9-12	11:02:54	
9	820	1640	2009-9-12	11:02:55	
10	830	1660	2009-9-12	11:02:56	
11	840	1680	2009-9-12	11:02:57	
12					



WUXI XINJE ELECTRIC CO., LTD.

4th Floor, Building 7th, No.100 Dicuti
Rd, Wuxi, China

Tel: 86-0510-85134139

Fax: 86-0510-85111290

www.xinje.com

Email: cheerfiona@gmail.com